



ROHS HF

### Cartridge Fuses

	<b>Φ5*20mm Ceramic Tube Fuse</b> Fast-Acting <b>571 Series</b> 	<b>Φ5*20mm Ceramic Tube Fuse</b> Fast-Acting <b>573 Series</b> 	<b>Φ5*20mm Ceramic Tube Fuse</b> Time-Lag <b>582 Series</b> 
Voltage Range	600VAC, 420VACDC	500VDC	600VAC, 500VDC
Ampere Range	200mA-20A	200mA-20A	500mA-20A
Breaking Capacity	300A@420VDC[200mA-20A] 200A@600VAC[1.25A-20A]	300A@500VDC, 2KA@400VDC[200mA-10A] 300A@500VDC[12A-20A]	200A@600VAC, 300A@500VDC, 2KA@400VDC[500mA-10A] 200A@600VAC, 300A@500VDC[12A-20A]

	<b>Φ6*30mm Glass Tube Fuse</b> Fast-Acting <b>611 Series</b> 	<b>Φ6*30mm Glass Tube Fuse</b> Time-Lag <b>612 Series</b> 	<b>Φ6*30mm Ceramic Tube Fuse</b> High I <sup>2</sup> T and Surge withstand to 20 cycles of 20kV <b>610 Series</b> 
Voltage Range	250VAC/125VAC	250VAC/125VAC	600VAC/150VDC
Ampere Range	500mA-25A	500mA-30A	21A
Breaking Capacity	10kA@125VAC, 35A@250VAC[500mA-800mA] 10kA@125VAC, 100A@250VAC[1A-3A] 10kA@125VAC, 200A@250VAC[3.15A-20A] 300A@125VAC[25A]	10kA@125VAC, 35A@250VAC[500mA-1A] 10kA@125VAC, 100A@250VAC[1.25A-3.5A] 10kA@125VAC, 200A@250VAC[4A-8A] 400A@125VAC, 200A@250VAC[10A-20A] 400A@125VAC, 100A@250VAC[25A-30A]	200A@600V AC 200A@150V DC

	<b>Φ6*30mm Ceramic Tube Fuse</b> Fast-Acting <b>613 Series</b> 	<b>Φ6*30mm Ceramic Tube Fuse</b> Time-Lag <b>614 Series</b> 	<b>Φ6*30mm Ceramic Tube Fuse</b> Fast-Acting <b>615 Series</b> 
Voltage Range	250VAC	250VAC/125VAC	1000VAC/660VAC
Ampere Range	500mA-25A	500mA-30A	500mA-10A
Breaking Capacity	10kA@125VAC, 35A@250VAC[500mA-1A] 10kA@125VAC, 100A@250VAC[1.25A-3.5A] 10kA@125VAC, 200A@250VAC[4A-10A] 400A@125VAC, 200A@250VAC[12A-20A] 400A@125VAC, 200A@250VAC[25A]	10kA@125VAC, 35A@250VAC[500A-800mA] 10kA@125VAC, 100A@250VAC[1A-3.5A] 10kA@125VAC, 200A@250VAC[4A-20A] 400A@125VAC, 100A@250VAC[500mA-30A]	100A@1000VAC[500mA-10A] 300A@660VAC[500mA-10A]



OC PROTECTION

## Cartridge Fuses / 500VDC-1000VDC

ROHS HF

Voltage Range  
Ampere Range  
Breaking Capacity

### Φ6\*30mm Ceramic Tube Fuse

Time-lag  
**616 Series**

250VAC  
15A-50A  
1500A@250VAC[15A-50A]

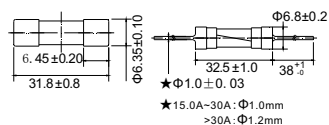

### Φ6\*30mm Ceramic Tube Fuse

Fast-Acting  
**617 Series**

250VAC/150VDC  
30A-50A  
\*40A High  
1500A@250VAC, 200A@150VDC

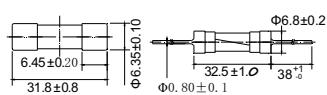

### Φ6\*30mm Ceramic Tube Fuse

Fast-Acting  
**619 Series**

660VAC/500VAC  
15A-40A  
400A@660VAC, 800A@500VAC

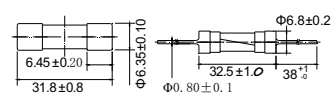

Voltage Range  
Ampere Range  
Breaking Capacity

### Φ6\*30mm Ceramic Tube Fuse

Fast-Acting  
**682 Series**

500VAC, 500VDC  
10A-30A  
30KA@500VAC[10A-30A]  
20KA@500VDC[10A-30A]

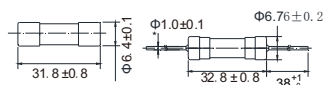

### Φ6\*30mm Ceramic Tube Fuse

Fast-Acting  
**683 Series**

500VAC, 500VDC  
20A-30A  
1KA@500VAC/DC[20A-30A]

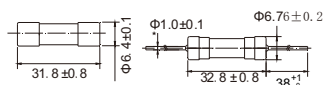

### Φ6\*30mm Ceramic Tube Fuse

Fast-Acting  
**691 Series**

600VAC, 600VDC  
200mA-12A  
10KA@600VAC/DC[200mA-12A]

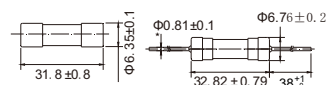

Voltage Range  
Ampere Range  
Breaking Capacity

### Φ6\*30mm Ceramic Tube Fuse

Fast-Acting  
**692 Series**

660VAC, 660VDC  
200mA-30A  
1KA@660VAC/DC[200mA-30A]

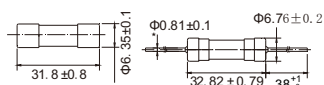

### Φ6\*30mm Ceramic Tube Fuse

Fast-Acting  
**693 Series**

1000VAC, 1000VDC  
200mA-3A  
10KA@1000VAC/DC[200mA-3A]



### Φ6\*30mm Ceramic Tube Fuse

Fast-Acting  
**697 Series**

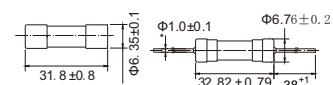

400VAC  
30A  
1KA@400VAC[30A]







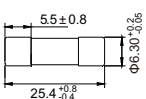
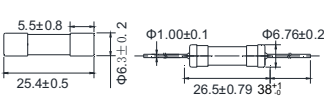
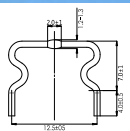

## Cartridge Fuses / Car Fuses / Through Hole Fuses

ROHS HF

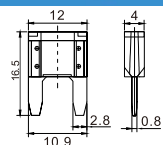
	<b>British Plug Top Fuse</b> Fast / Medium <b>AF63 Series, BS1362-1973</b>	<b>Φ6*25mm Ceramic Tube Fuse</b> Time-Lag <b>671 Series</b>	<b>Φ12.5*11mm melting wire Fuse</b> <b>253 Series</b>
Voltage Range	264VAC	75VDC	80VDC
Ampere Range	1A, 2A, 3A, 5A, 7A, 10A, 13A	5A-50A	30A~100A
Breaking Capacity	6KA@264VAC[1A~13A]	2.5kA@75VDC[5A-50A]	
			
			

	<b>Φ6*40mm Glass Tube Fuse</b> Fast-Acting, Microwave Dedicated <b>720 Series</b>	<b>Φ6*40mm Glass Tube Fuse</b> Fast-Acting, Microwave Dedicated <b>721 Series</b>	<b>Small Car Fuse Mini</b> <b>BF2 Series</b>
Voltage Range	5KVAC	5KVAC	32VDC
Ampere Range	400mA~1A	400mA~1A	3~30A
Breaking Capacity	5KVAC[400mA~1A]	5KVAC[400mA~1A]	1000A@32VDC[3~30A]
			
			

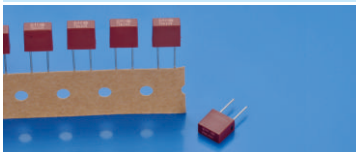
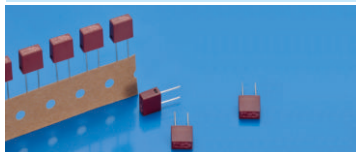
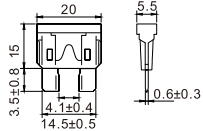
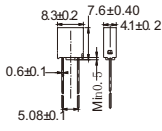
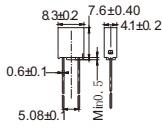
	<b>Middle Car Fuse Max</b> <b>718&amp;BF4 Series</b>	<b>TE5 Fuse</b> Fast-Acting <b>931 Series</b>	<b>TE5 Fuse</b> Time-Lag <b>932 Series</b>
Voltage Range	32VDC	250VAC	300VAC/250VAC
Ampere Range	2~40A	100mA~10A	100mA~10A
Breaking Capacity	1000A@32VDC[2~40A]	130A@125/250VAC[100mA~10A]	100A@250VAC[100mA~10A], 50A or 10In@300VAC[100mA~10A]
			
			



OCC PROTECTION