

**1.00MM PITCH FLAT CABLE WITH 2*
2.00MM PITCH IDC SOCKET WITHOUT STRAIN RELIEF (H=9.0MM) (A1)**

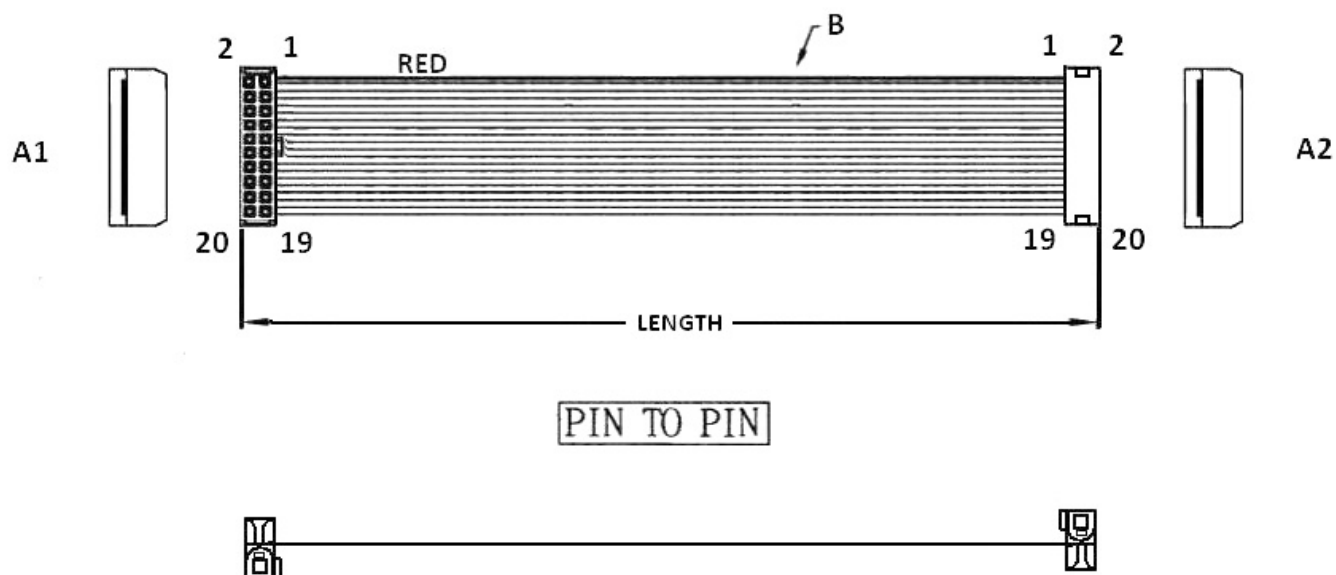

ORDERING INFORMATION:

P/N $\frac{\text{KB}}{1}$ $\frac{\text{xx}}{2}$ $\frac{\text{KK}}{3}$ - $\frac{\text{xx}}{4}$ **CM** $\frac{\text{B}}{5}$

1. FLAT CABLE TYPE:
"KB" 1.00MM AWG28 UL2651 VW-1
PVC INSULATION GRAY
2. NO. OF CONTACTS:
06~68
3. CONNECTORS AT TWO ENDS:
"KK" 2.00MM IDC SOCKET WITH NOSE W/O S.R. TO
2.00MM IDC SOCKET WITH NOSE W/O S.R.
4. LENGTH IN CM (CENTIMETERS)
5. COLOR OF TWO IDC CONNECTORS:
"B" BLACK

**1.00MM PITCH FLAT CABLE WITH 2*
2.00MM PITCH IDC SOCKETS WITHOUT STRAIN RELIEF (H=9.0MM) (A2)**

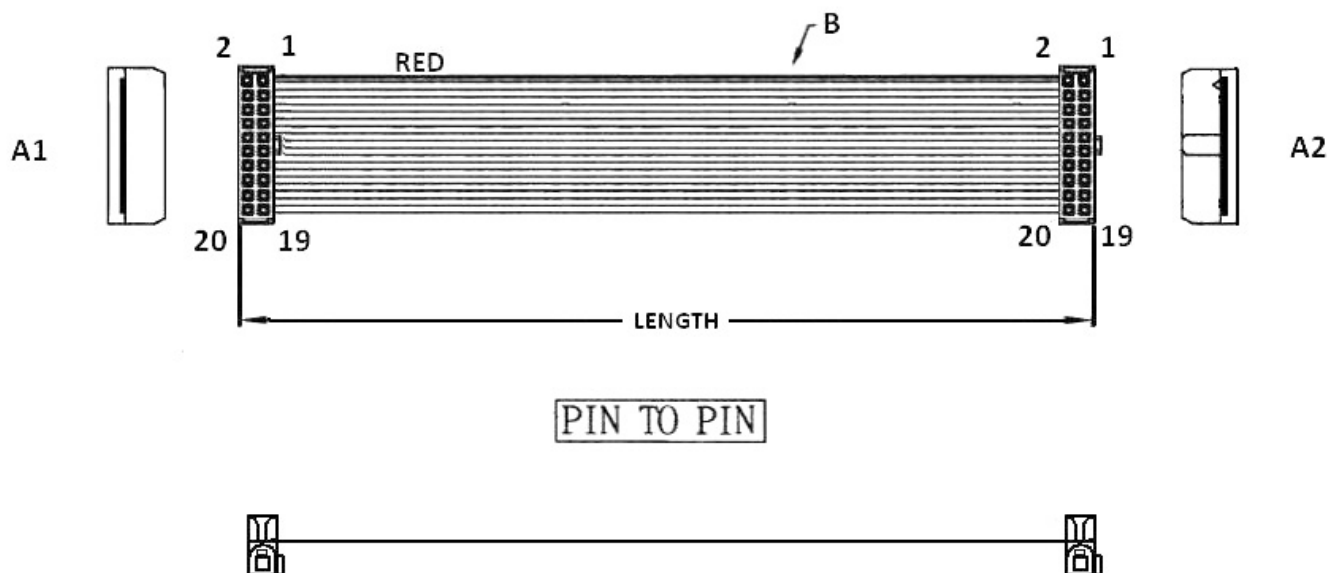

ORDERING INFORMATION:

P/N $\frac{\text{KB}}{1}$ $\frac{\text{xx}}{2}$ $\frac{\text{KL}}{3}$ - $\frac{\text{xx}}{4}$ **CM** $\frac{\text{B}}{5}$

1. FLAT CABLE TYPE:
"KB" 1.00MM AWG28 UL2651 VW-1
PVC INSULATION GRAY
2. NO. OF CONTACTS:
06~68
3. CONNECTORS AT TWO ENDS:
"KL" 2.00MM IDC SOCKET WITH NOSE W/O S.R. TO
2.00MM IDC SOCKET WITH NOSE W/O S.R.
4. LENGTH IN CM (CENTIMETERS)
5. COLOR OF TWO IDC CONNECTORS:
"B" BLACK

**1.00MM PITCH FLAT CABLE WITH 2*
2.00MM PITCH IDC SOCKETS WITHOUT STRAIN RELIEF (H=9.0MM) (A3)**

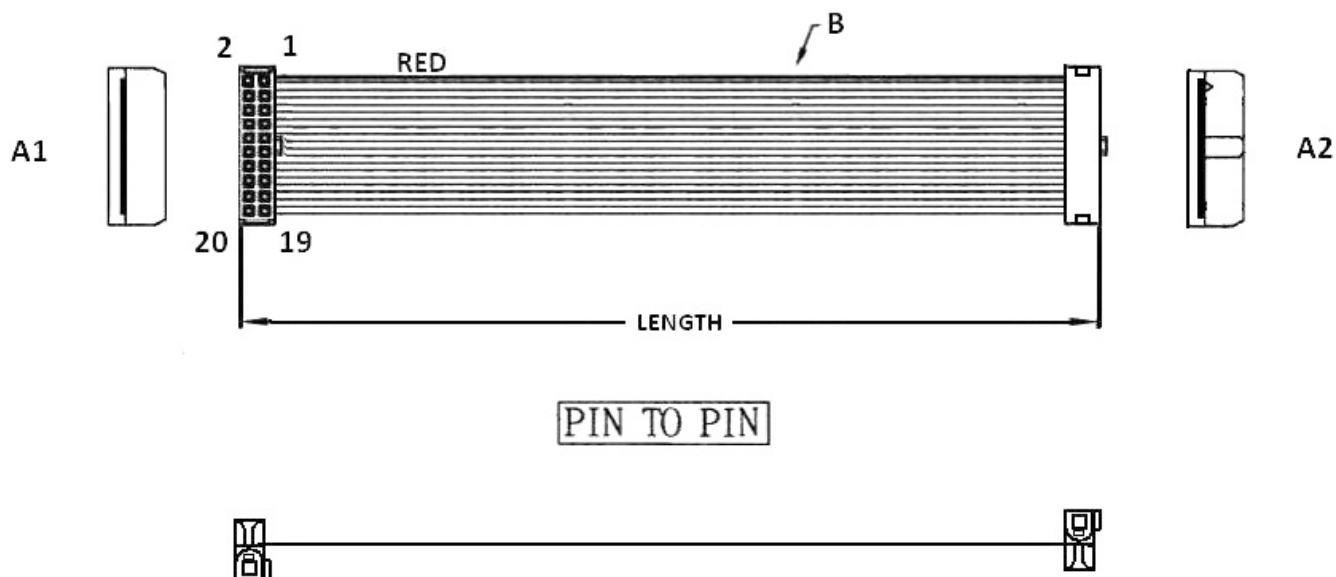

ORDERING INFORMATION:

P/N $\frac{\text{KB}}{1}$ $\frac{\text{xx}}{2}$ $\frac{\text{KI}}{3}$ - $\frac{\text{xx}}{4}$ **CM** $\frac{\text{B}}{5}$

1. FLAT CABLE TYPE:
"KB" 1.00MM AWG28 UL2651 VW-1
PVC INSULATION GRAY
2. NO. OF CONTACTS:
06~68
3. CONNECTORS AT TWO ENDS:
"KI" 2.00MM IDC SOCKET WITH NOSE W/O S.R. TO
2.00MM IDC SOCKET WITH NOSE W/O S.R.
4. LENGTH IN CM (CENTIMETERS)
5. COLOR OF TWO IDC CONNECTORS:
"B" BLACK

**1.00MM PITCH FLAT CABLE WITH 2*
2.00MM PITCH IDC SOCKETS WITHOUT STRAIN RELIEF (H=9.0MM) (A4)**

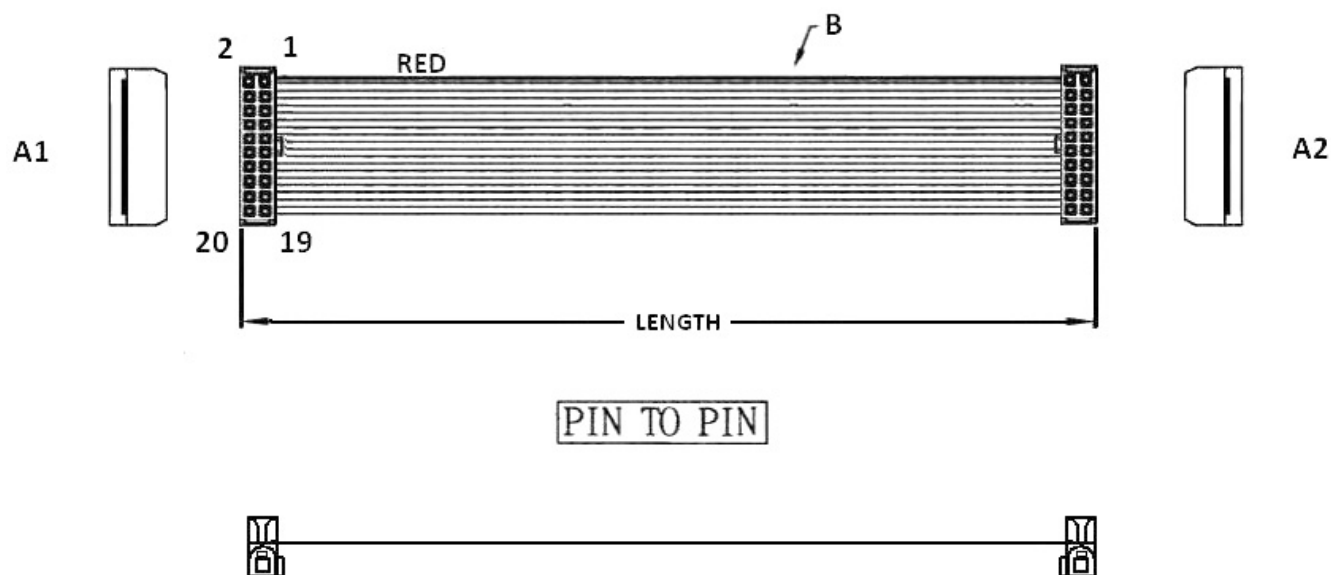

ORDERING INFORMATION:

P/N $\frac{KB}{1}$ $\frac{xx}{2}$ $\frac{K8}{3}$ - $\frac{xx}{4}$ **CM** $\frac{B}{5}$

1. FLAT CABLE TYPE:
"KB" 1.00MM AWG28 UL2651 VW-1
PVC INSULATION GRAY
2. NO. OF CONTACTS:
06~68
3. CONNECTORS AT TWO ENDS:
"K8" 2.00MM IDC SOCKET WITH NOSE W/O S.R. TO
2.00MM IDC SOCKET WITH NOSE W/O S.R.
4. LENGTH IN CM (CENTIMETERS)
5. COLOR OF TWO IDC CONNECTORS:
"B" BLACK

**1.00MM PITCH FLAT CABLE WITH 2*
2.00MM PITCH IDC SOCKETS WITHOUT STRAIN RELIEF (H=9.0MM) (A5)**

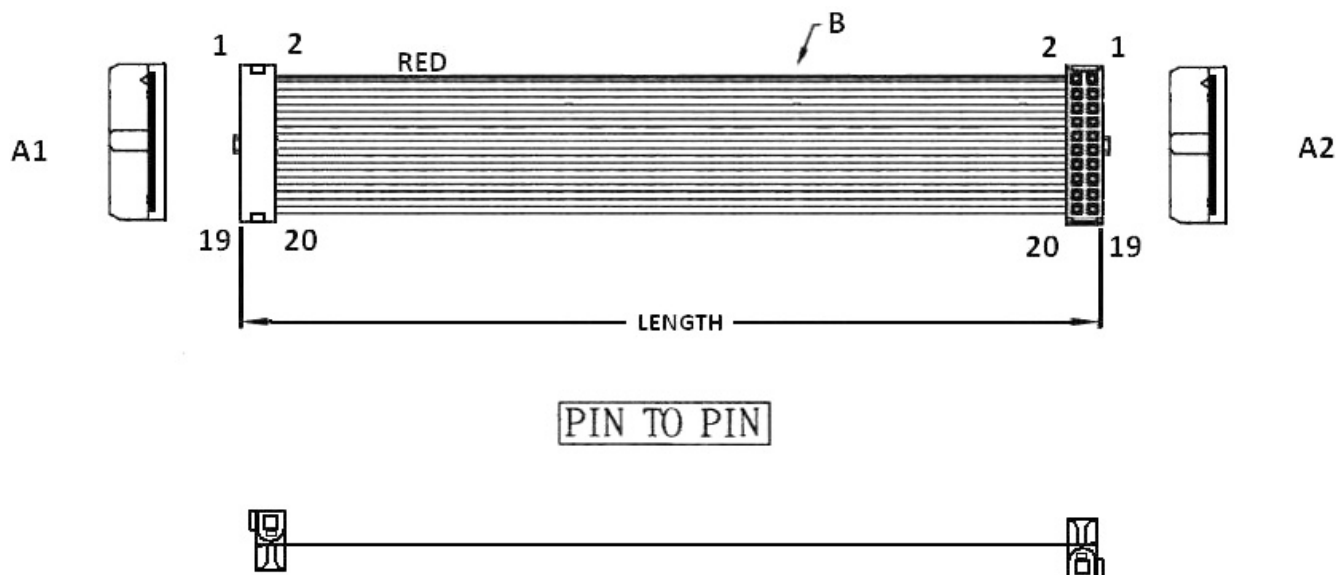

ORDERING INFORMATION:

P/N $\frac{KB}{1}$ $\frac{xx}{2}$ $\frac{LL}{3}$ - $\frac{xx}{4}$ **CM** $\frac{B}{5}$

1. FLAT CABLE TYPE:
"KB" 1.00MM AWG28 UL2651 VW-1
PVC INSULATION GRAY
2. NO. OF CONTACTS:
06~68
3. CONNECTORS AT TWO ENDS:
"LL" 2.00MM IDC SOCKET WITH NOSE W/O S.R. TO
2.00MM IDC SOCKET WITH NOSE W/O S.R.
4. LENGTH IN CM (CENTIMETERS)
5. COLOR OF TWO IDC CONNECTORS:
"B" BLACK

**1.00MM PITCH FLAT CABLE WITH 2*
2.00MM PITCH IDC SOCKETS WITHOUT STRAIN RELIEF (H=9.0MM) (A6)**

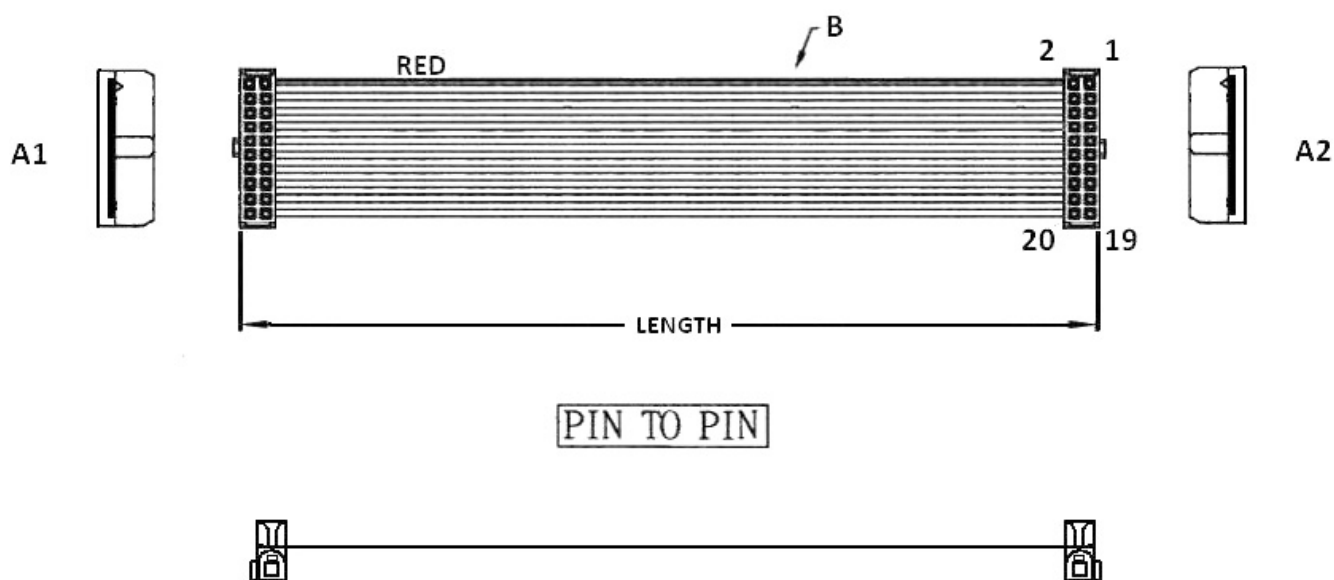

ORDERING INFORMATION:

P/N $\frac{KB}{1}$ $\frac{xx}{2}$ $\frac{LI}{3}$ - $\frac{xx}{4}$ **CM** $\frac{B}{5}$

1. FLAT CABLE TYPE:
"KB" 1.00MM AWG28 UL2651 VW-1
PVC INSULATION GRAY
2. NO. OF CONTACTS:
06~68
3. CONNECTORS AT TWO ENDS:
"LI" 2.00MM IDC SOCKET WITH NOSE W/O S.R. TO
2.00MM IDC SOCKET WITH NOSE W/O S.R.
4. LENGTH IN CM (CENTIMETERS)
5. COLOR OF TWO IDC CONNECTORS:
"B" BLACK

1.00MM PITCH FLAT CABLE WITH 2* 2.00MM IDC SOCKETS (H=5.1MM) (A7)

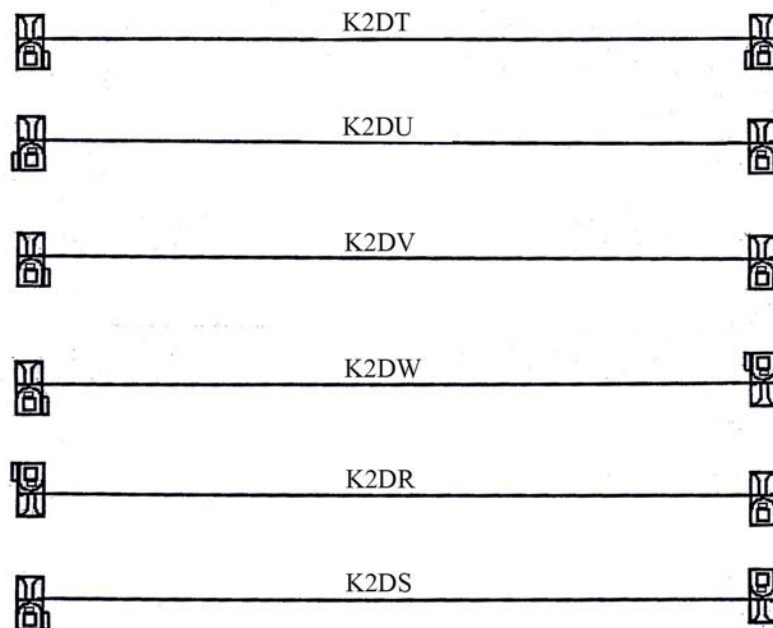

2.00MM PITCH IDC SOCKET WITH INTENSIVE CONTACTS & WITHOUT STRAIN RELIEF

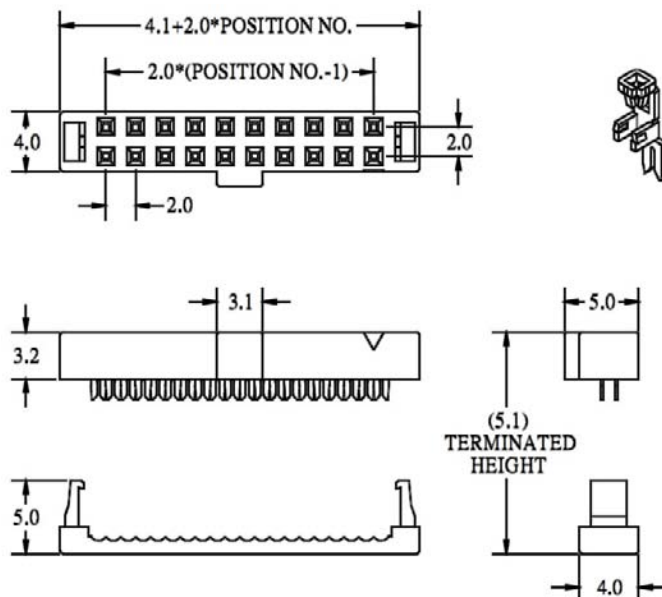

NO. OF CONTACTS:
006, 008, 010, 012, 014,
016, 020, 022, 024, 026,
030, 034, 036, 040, 044,
050

ORDERING INFORMATION:

P/N **K** **x x x x x x** - **x x** **C M B**

1 2 3 4

1. CONSTRUCTION TYPE:
2DT, 2DU, 2DV, 2DW, 2DR, 2DS
2. NO. OF CONTACTS:
006~050
3. LENGTH IN CM (CENTIMETERS)
4. COLOR OF TWO IDC CONNECTORS:
"B" BLACK

NOTE: IDC SOCKET CAN'T BE SUPPLIED ALONE.

1.00MM PITCH FLAT CABLE WITH 2* 2.00MM IDC SOCKETS (H=7.5MM) (A8)

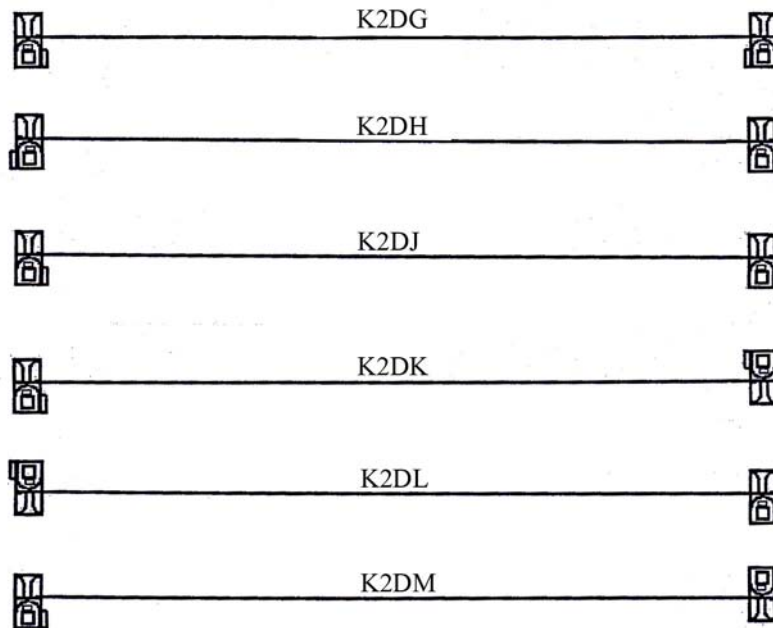

2.00MM PITCH IDC SOCKET WITH CENTRAL BUMP & FRICTION LATCH

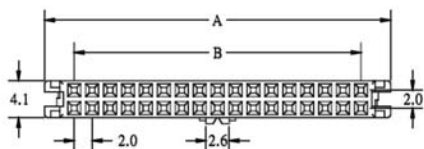

$$A=B+6.6$$

$$B=2.00*\text{POSITIONS}/2-2.00$$

$$C=B+3.2$$

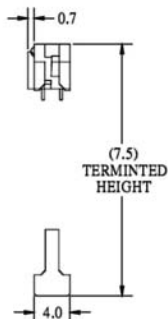
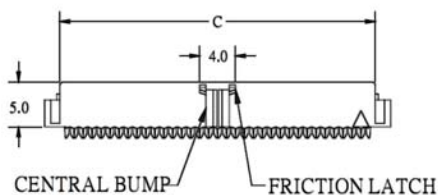

NO. OF CONTACTS:
006, 008, 010, 012, 014,
016, 018, 020, 022, 024,
026, 028, 030, 034, 036,
040, 044, 048, 050, 060,
064, 068



ORDERING INFORMATION:

P/N **K** **x x x x x x** - **x x** **C M B**

1 2 3 4

1. CONSTRUCTION TYPE:
2DG, 2DH, 2DJ, 2DK, 2DL, 2DM
2. NO. OF CONTACTS:
006~068
3. LENGTH IN CM (CENTIMETERS)
4. COLOR OF TWO IDC CONNECTORS:
"B" BLACK

NOTE: IDC SOCKET CAN'T BE SUPPLIED ALONE.

1.00MM PITCH FLAT CABLE WITH 2* 2.00MM IDC SOCKETS (H=8.5MM) (A9)

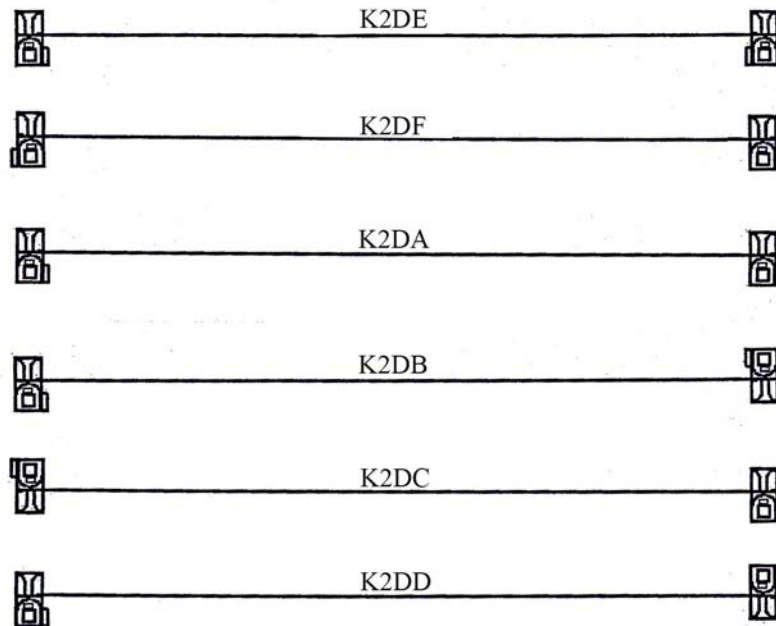

2.00MM PITCH IDC SOCKET WITHOUT S.R. ECONOMICAL TYPE

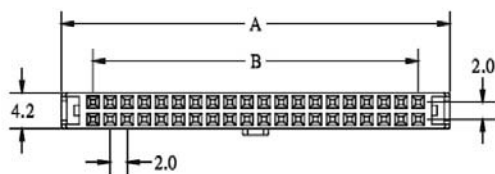

$$A=B+7.2$$

$$B=2.00*\text{POSITIONS}/2-2.00$$

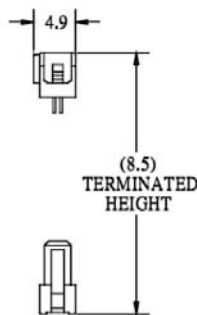
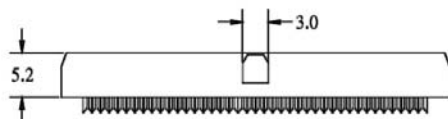

NO. OF CONTACTS:
006, 008, 010, 012, 014,
016, 018, 020, 022, 024,
026, 030, 032, 034, 036,
038, 040, 044, 048, 050,
056, 060, 064, 068



ORDERING INFORMATION:

P/N **K** **x x x x x x** - **x x** **C M B**

1 2 3 4

1. CONSTRUCTION TYPE:
2DE, 2DF, 2DA, 2DB, 2DC, 2DD
2. NO. OF CONTACTS:
006~068
3. LENGTH IN CM (CENTIMETERS)
4. COLOR OF TWO IDC CONNECTORS:
"B" BLACK

NOTE: IDC SOCKET CAN'T BE SUPPLIED ALONE.

1.00MM PITCH FLAT CABLE WITH 2* 2.00MM IDC SOCKETS (H=8.5MM) (A10)

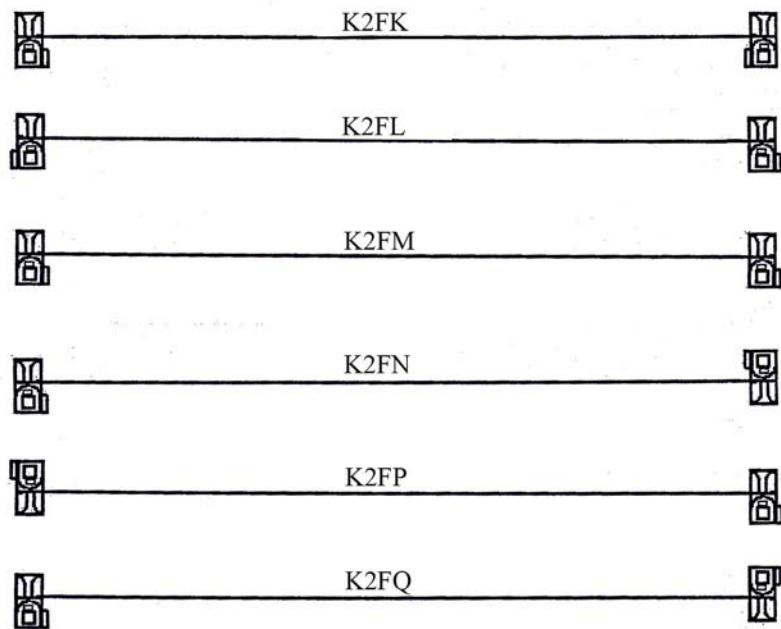

2.00MM PITCH IDC SOCKET WITH HOOKY TERMINATIONS & WITHOUT STRAIN RELIEF

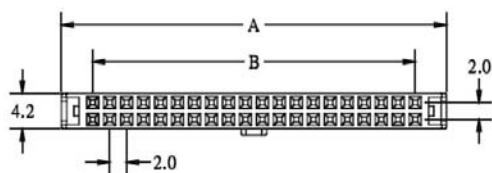

$$A=B+7.20$$

$$B=2.00*\text{POSITIONS}/2-2.00$$

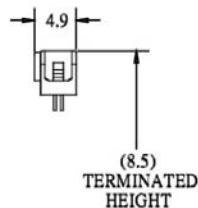
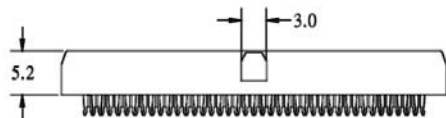

NO. OF CONTACTS:
006, 008, 010, 012, 014,
016, 018, 020, 022, 024,
026, 030, 032, 034, 036,
038, 040, 044, 048, 050,
056, 060, 064, 068



ORDERING INFORMATION:

P/N **K** **x x x x x x** - **x x** **C M B**

1 2 3 4

1. CONSTRUCTION TYPE:
2FK, 2FL, 2FM, 2FN, 2FP, 2FQ
2. NO. OF CONTACTS:
006~068
3. LENGTH IN CM (CENTIMETERS)
4. COLOR OF TWO IDC CONNECTORS:
"B" BLACK

NOTE: IDC SOCKET CAN'T BE SUPPLIED ALONE.

1.00MM PITCH FLAT CABLE WITH 2* 2.00MM SHRUNK IDC SOCKETS (H=8.5MM) (A11)

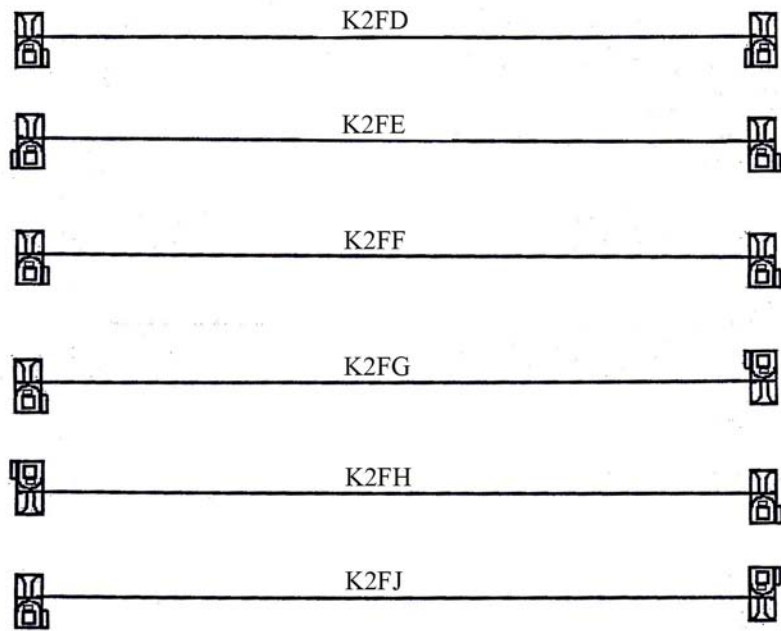

2.00MM PITCH SHRUNK IDC SOCKET WITHOUT STRAIN RELIEF

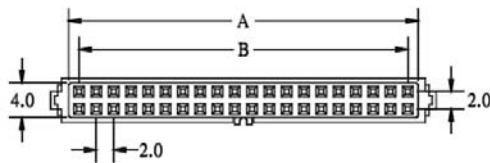

$$A=B+2.4$$

$$B=2.00*\text{POSITIONS}/2-2.00$$

$$C=B+7.17$$

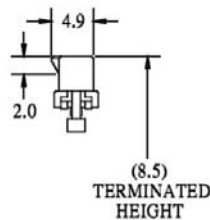
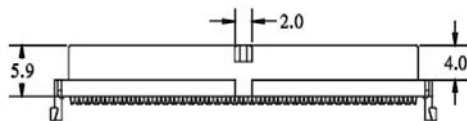

NO. OF CONTACTS:
006, 008, 010, 012, 014,
016, 020, 022, 024, 026,
030, 034, 040, 044, 050,
068

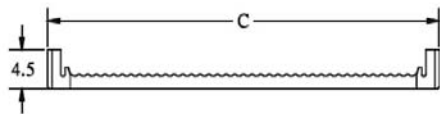

ORDERING INFORMATION:

P/N **K** **x x x x x x** - **x x** **C M B**

1 2 3 4

1. CONSTRUCTION TYPE:
2FD, 2FE, 2FF, 2FG, 2FH, 2FJ
2. NO. OF CONTACTS:
006~068
3. LENGTH IN CM (CENTIMETERS)
4. COLOR OF TWO IDC CONNECTORS:
"B" BLACK

NOTE: IDC SOCKET CAN'T BE SUPPLIED ALONE.

1.00MM PITCH FLAT CABLE WITH 2* 2.00MM IDC SOCKETS (H=9.2MM) (A12)

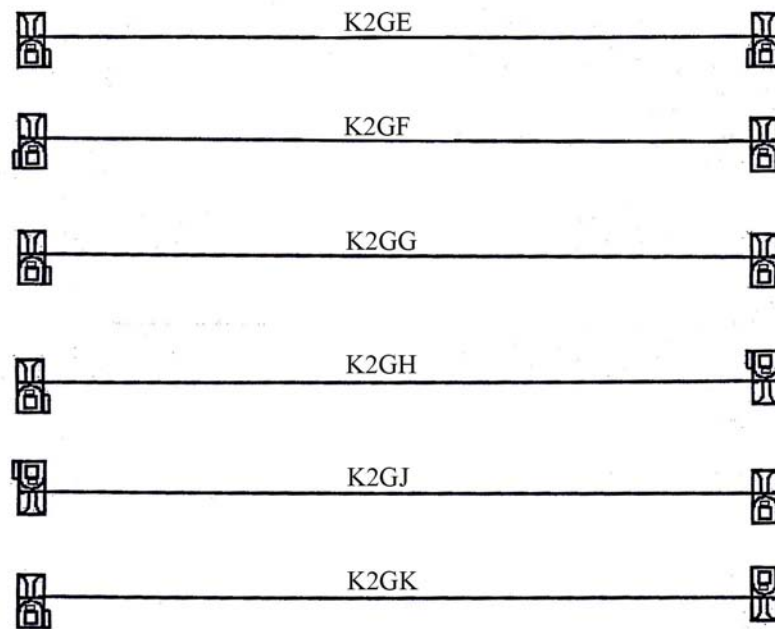

2.00MM PITCH IDC SOCKET WITH RAMP LOCKING & WITHOUT STRAIN RELIEF

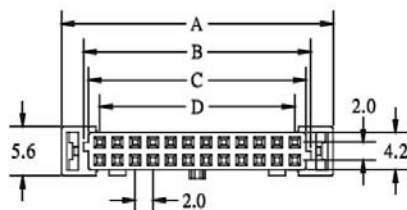

$$\begin{aligned}
 A &= D + 8.65 \\
 B &= D + 3.65 \\
 C &= D + 2.55 \\
 D &= 2.00 * \text{POSITIONS} / 2 - 2.00 \\
 E &= D + 6.90
 \end{aligned}$$

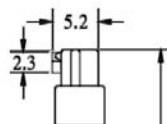
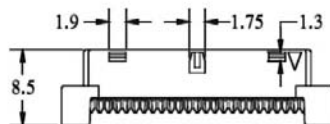

NO. OF CONTACTS:
010, 012, 014, 016, 020,
022, 024, 026, 030, 034,
040, 044, 050, 068

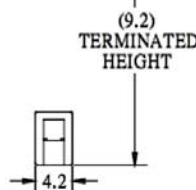
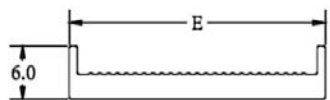

ORDERING INFORMATION:

P/N **K** **x x x x x x** - **x x** **C M B**

1 2 3 4

1. CONSTRUCTION TYPE:
2GE, 2GF, 2GG, 2GH, 2GJ, 2GK
2. NO. OF CONTACTS:
010~068
3. LENGTH IN CM (CENTIMETERS)
4. COLOR OF TWO IDC CONNECTORS:
"B" BLACK

NOTE: IDC SOCKET CAN'T BE SUPPLIED ALONE.

**1.00MM PITCH FLAT CABLE WITH 2*
2.00MM PITCH IDC SOCKETS WITHOUT NOSE (H=9.0MM) (B1)**

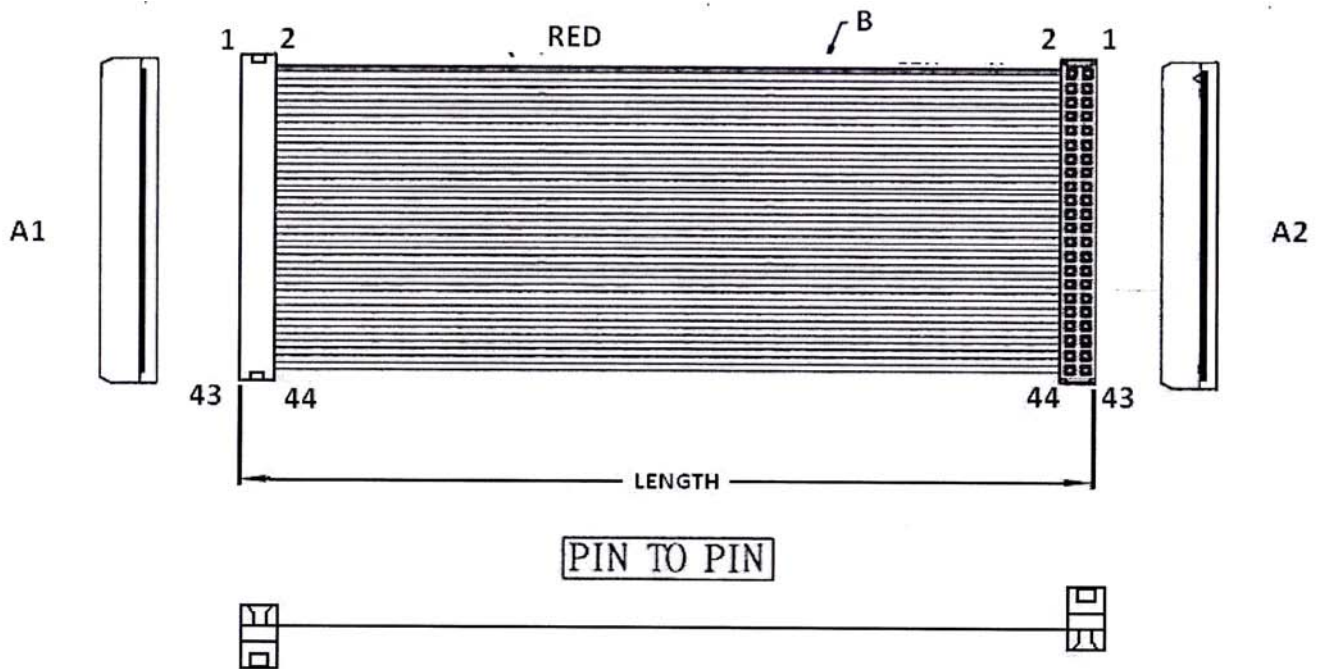

ORDERING INFORMATION:

P/N $\frac{KB}{1}$ $\frac{xx}{2}$ $\frac{AA}{3}$ - $\frac{xx}{4}$ **CM** $\frac{B}{5}$

1. FLAT CABLE TYPE:
"KB" 1.00MM AWG28 UL2651 VW-1
PVC INSULATION GRAY
2. NO. OF CONTACTS:
06~68
3. CONNECTORS AT TWO ENDS:
"AA" 2.00MM IDC SOCKET W/O NOSE W/O S.R.
TO 2.00MM IDC SOCKET W/O NOSE W/O S.R.
4. LENGTH IN CM (CENTIMETERS)
5. COLOR OF TWO IDC CONNECTORS:
"B" BLACK

**1.00MM PITCH FLAT CABLE WITH 2*
2.00MM PITCH IDC SOCKETS WITHOUT NOSE (H=9.0MM) (B2)**

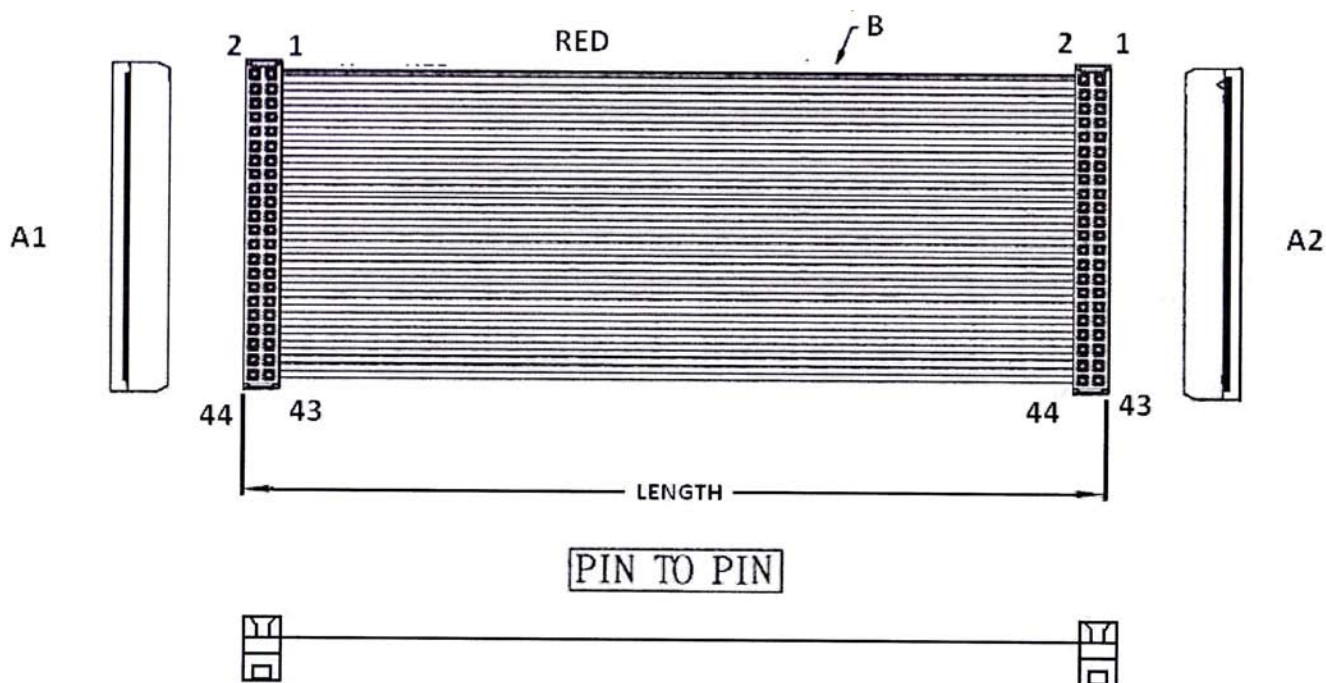

ORDERING INFORMATION:

P/N $\frac{KB}{1}$ $\frac{xx}{2}$ $\frac{AV}{3}$ - $\frac{xx}{4}$ **CM** $\frac{B}{5}$

1. FLAT CABLE TYPE:
"KB" 1.00MM AWG28 UL2651 VW-1
PVC INSULATION GRAY
2. NO. OF CONTACTS:
06~68
3. CONNECTORS AT TWO ENDS:
"AV" 2.00MM IDC SOCKET W/O NOSE W/O S.R.
TO 2.00MM IDC SOCKET W/O NOSE W/O S.R.
4. LENGTH IN CM (CENTIMETERS)
5. COLOR OF TWO IDC CONNECTORS:
"B" BLACK

**1.00MM PITCH FLAT CABLE WITH 2*
2.00MM PITCH IDC SOCKETS WITHOUT NOSE (H=9.0MM) (B3)**

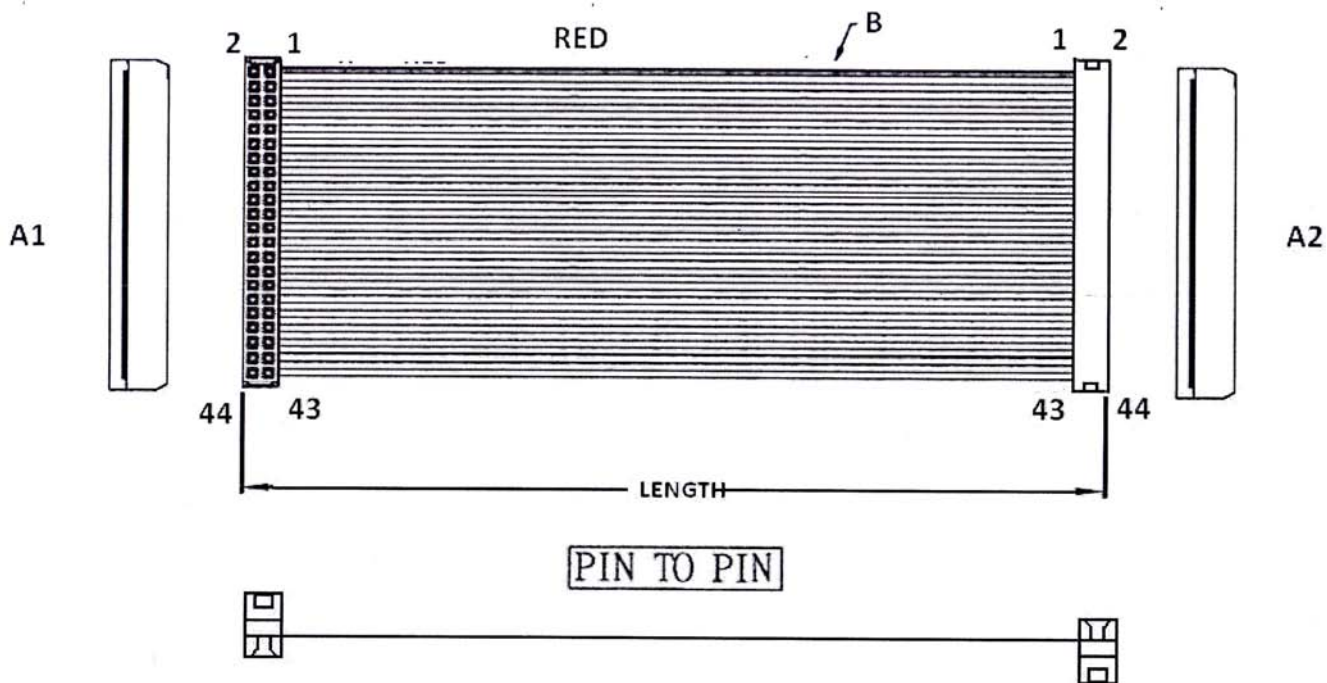

ORDERING INFORMATION:

P/N $\frac{KB}{1}$ $\frac{xx}{2}$ $\frac{VV}{3}$ - $\frac{xx}{4}$ **CM** $\frac{B}{5}$

1. FLAT CABLE TYPE:
"KB" 1.00MM AWG28 UL2651 VW-1
PVC INSULATION GRAY
2. NO. OF CONTACTS:
06~68
3. CONNECTORS AT TWO ENDS:
"VV" 2.00MM IDC SOCKET W/O NOSE W/O S.R.
TO 2.00MM IDC SOCKET W/O NOSE W/O S.R.
4. LENGTH IN CM (CENTIMETERS)
5. COLOR OF TWO IDC CONNECTORS:
"B" BLACK

**1.00MM PITCH FLAT CABLE WITH
2* 2.00MM LOW PROFILE IDC SOCKETS W/O NOSE (H=7.4MM) (B4)**

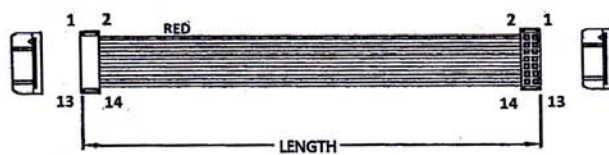
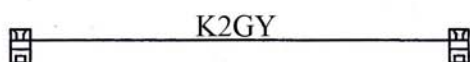
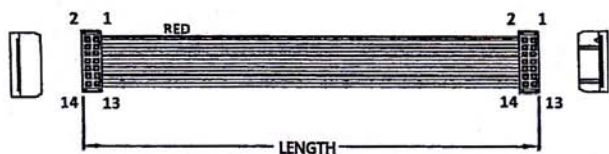

ORDERING INFORMATION:

P/N K 1 2 3 4

1. CONSTRUCTION TYPE:
2GX, 2GY, 2GZ
2. NO. OF CONTACTS:
008~050
3. LENGTH IN CM (CENTIMETERS)
4. COLOR OF TWO IDC CONNECTORS:
"B" BLACK

**1.00MM PITCH FLAT CABLE WITH 2*
2.00MM PITCH IDC SOCKETS WITH STRAIN RELIEFS (H=13.0MM) (C1)**

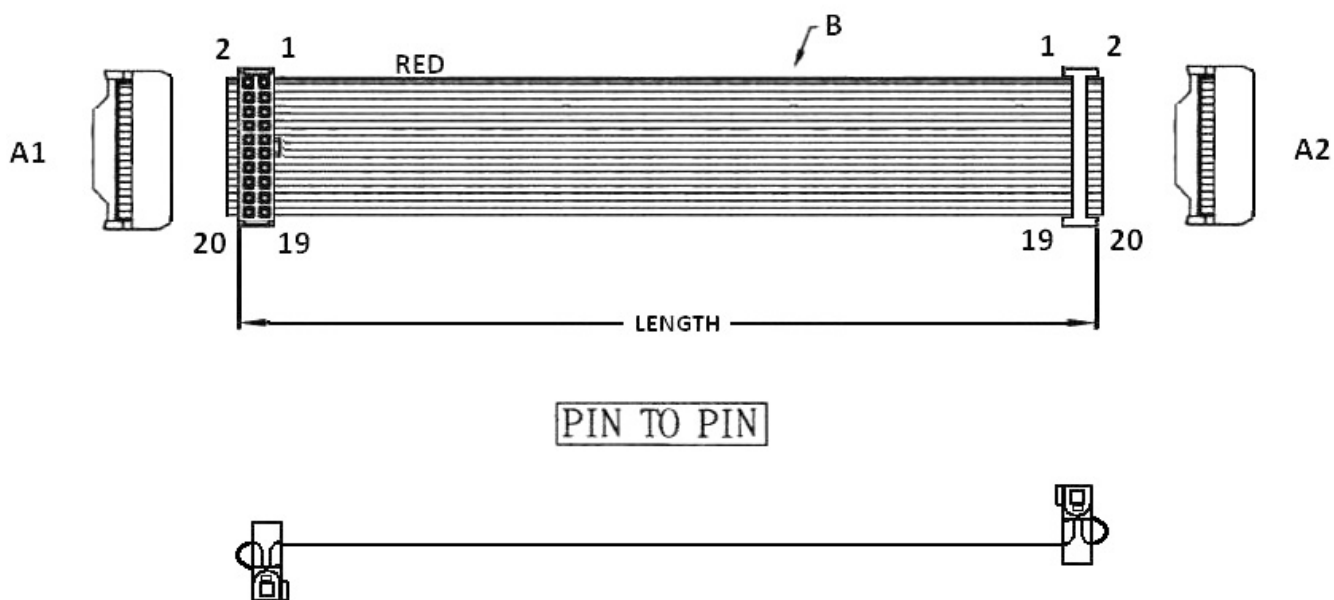

PIN TO PIN

ORDERING INFORMATION:

P/N $\frac{KB}{1}$ $\frac{xx}{2}$ $\frac{MM}{3}$ - $\frac{xx}{4}$ **CM** $\frac{B}{5}$

1. FLAT CABLE TYPE:
"KB" 1.00MM AWG28 UL2651 VW-1
PVC INSULATION GRAY
2. NO. OF CONTACTS:
06~68
3. CONNECTORS AT TWO ENDS:
"MM" 2.00MM IDC SOCKET WITH NOSE & S.R. TO
2.00MM IDC SOCKET WITH NOSE & S.R.
4. LENGTH IN CM (CENTIMETERS)
5. COLOR OF TWO IDC CONNECTORS:
"B" BLACK

**1.00MM PITCH FLAT CABLE WITH 2*
2.00MM PITCH IDC SOCKETS WITH STRAIN RELIEFS (H=13.0MM) (C2)**

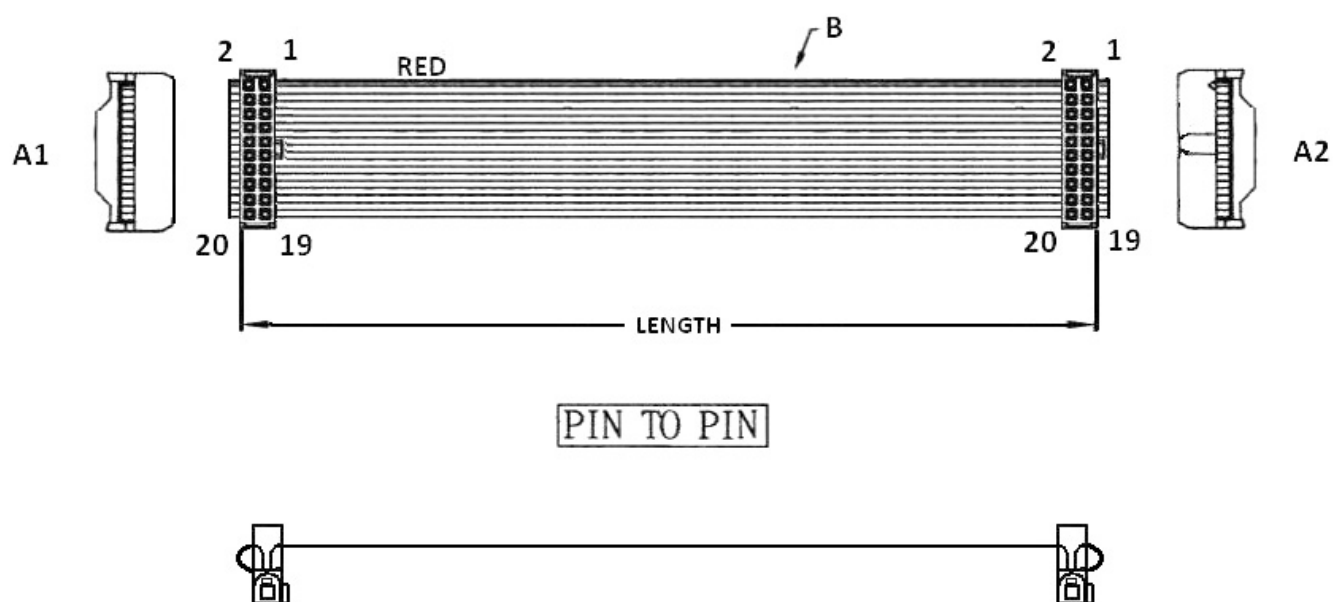

ORDERING INFORMATION:

P/N $\frac{\text{KB}}{1}$ $\frac{\text{xx}}{2}$ $\frac{\text{MN}}{3}$ - $\frac{\text{xx}}{4}$ **CM** $\frac{\text{B}}{5}$

1. FLAT CABLE TYPE:
"KB" 1.00MM AWG28 UL2651 VW-1
PVC INSULATION GRAY
2. NO. OF CONTACTS:
06~68
3. CONNECTORS AT TWO ENDS:
"MN" 2.00MM IDC SOCKET WITH NOSE & S.R. TO
2.00MM IDC SOCKET WITH NOSE & S.R.
4. LENGTH IN CM (CENTIMETERS)
5. COLOR OF TWO IDC CONNECTORS:
"B" BLACK

**1.00MM PITCH FLAT CABLE WITH 2*
2.00MM PITCH IDC SOCKETS WITH STRAIN RELIEFS (H=13.0MM) (C3)**

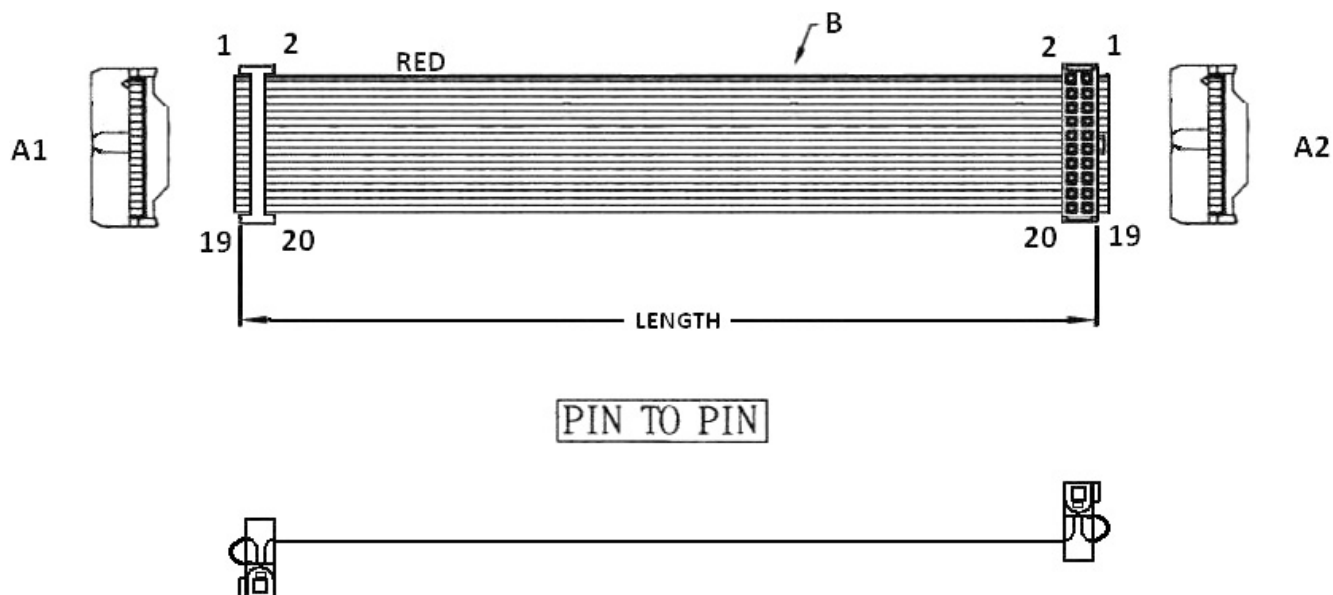

PIN TO PIN

ORDERING INFORMATION:

P/N $\frac{\text{KB}}{1}$ $\frac{\text{xx}}{2}$ $\frac{\text{NN}}{3}$ - $\frac{\text{xx}}{4}$ **CM** $\frac{\text{B}}{5}$

1. FLAT CABLE TYPE:
"KB" 1.00MM AWG28 UL2651 VW-1
PVC INSULATION GRAY
2. NO. OF CONTACTS:
06~68
3. CONNECTORS AT TWO ENDS:
"NN" 2.00MM IDC SOCKET WITH NOSE & S.R. TO
2.00MM IDC SOCKET WITH NOSE & S.R.
4. LENGTH IN CM (CENTIMETERS)
5. COLOR OF TWO IDC CONNECTORS:
"B" BLACK

**1.00MM PITCH FLAT CABLE WITH 2*
2.00MM PITCH IDC SOCKETS WITH STRAIN RELIEFS (H=13.0MM) (C4)**

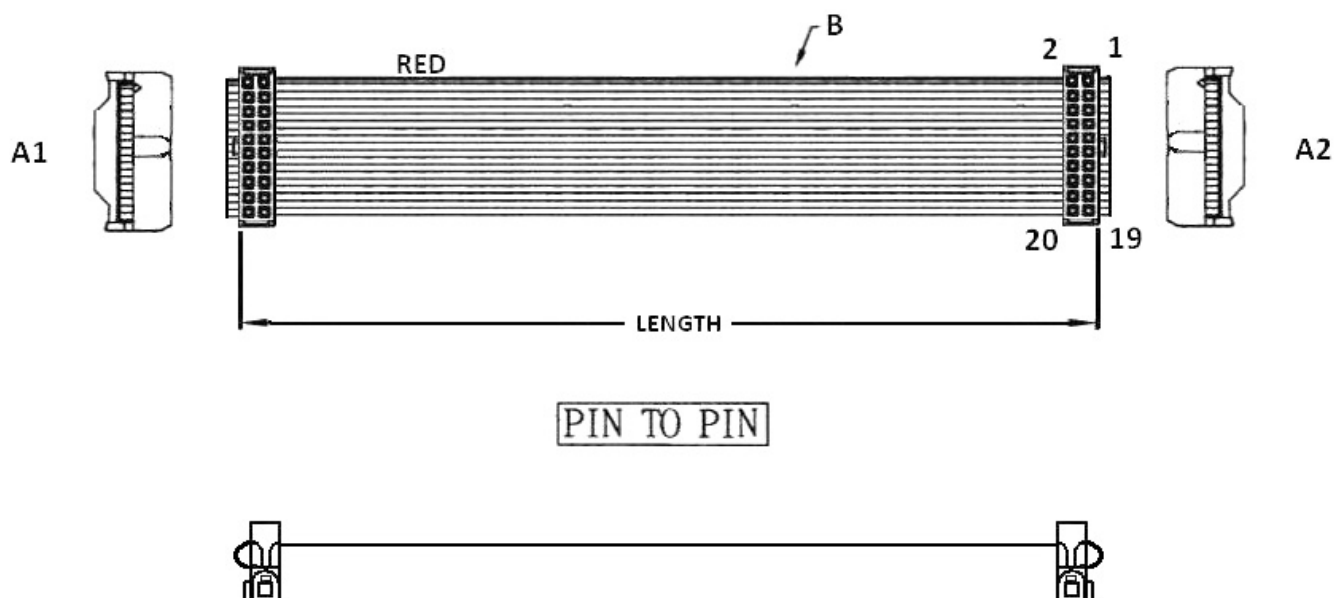

ORDERING INFORMATION:

P/N $\frac{KB}{1}$ $\frac{xx}{2}$ $\frac{NX}{3}$ - $\frac{xx}{4}$ **CM** $\frac{B}{5}$

1. FLAT CABLE TYPE:
"KB" 1.00MM AWG28 UL2651 VW-1
PVC INSULATION GRAY
2. NO. OF CONTACTS:
06~68
3. CONNECTORS AT TWO ENDS:
"NX" 2.00MM IDC SOCKET WITH NOSE & S.R. TO
2.00MM IDC SOCKET WITH NOSE & S.R.
4. LENGTH IN CM (CENTIMETERS)
5. COLOR OF TWO IDC CONNECTORS:
"B" BLACK

**1.00MM PITCH FLAT CABLE WITH
2* 2.00MM PITCH IDC SOCKETS WITH STRAIN RELIEFS (H=13.0MM) (C5)**

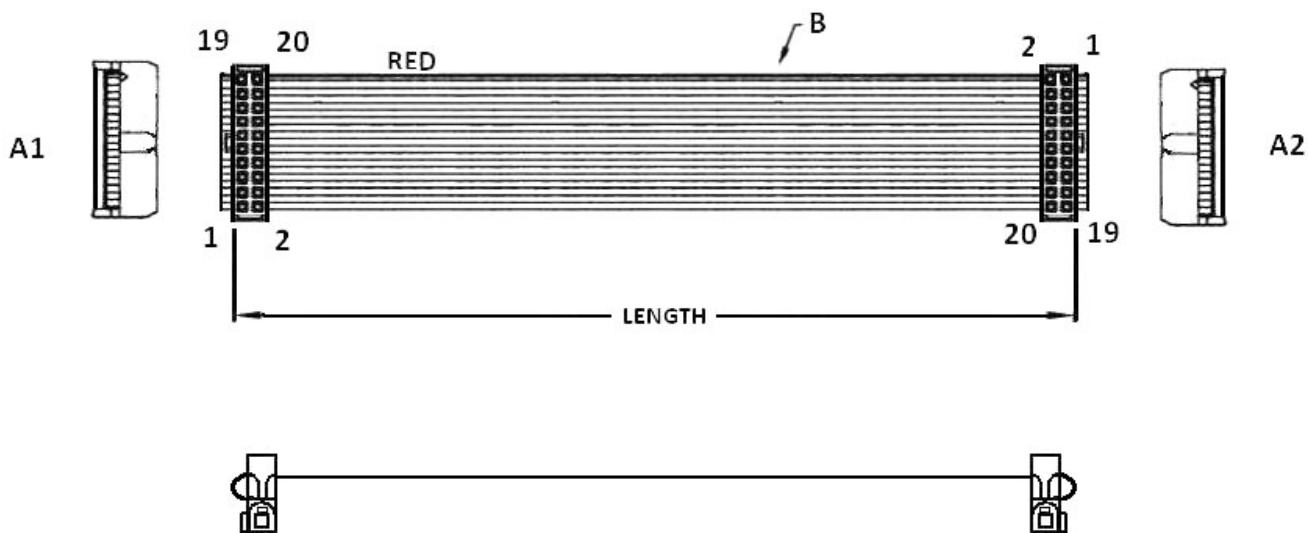

ORDERING INFORMATION:

P/N $\frac{\text{KB}}{1}$ $\frac{\text{xx}}{2}$ $\frac{\text{NI}}{3}$ - $\frac{\text{xx}}{4}$ **CM** $\frac{\text{B}}{5}$

1. FLAT CABLE TYPE:
"KB" 1.00MM AWG28 UL2651 VW-1
PVC INSULATION GRAY
2. NO. OF CONTACTS:
06~68
3. CONNECTORS AT TWO ENDS:
"NI" 2.00MM IDC SOCKET WITH NOSE & S.R.
TO 2.00MM IDC SOCKET WITH NOSE & S.R.
4. LENGTH IN CM (CENTIMETERS)
5. COLOR OF TWO IDC CONNECTORS:
"B" BLACK

1.00MM PITCH FLAT CABLE WITH 2* 2.00MM IDC SOCKETS (H=7.8MM) (C6)

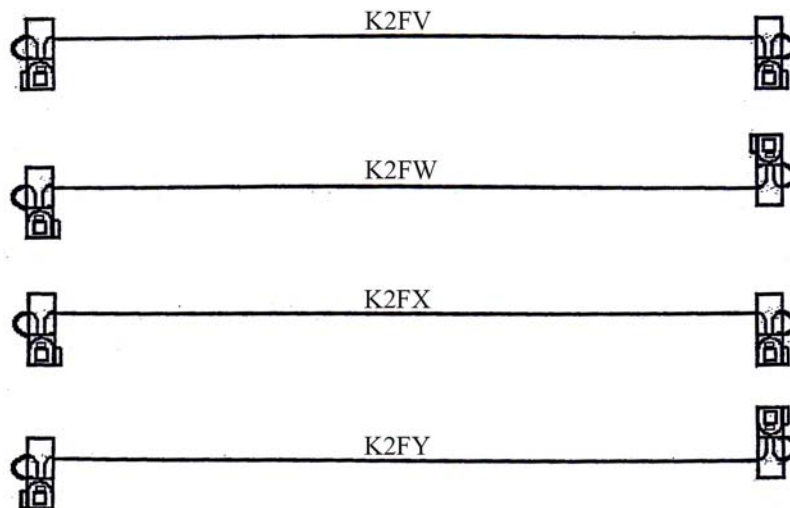

2.00MM PITCH IDC SOCKET WITH INTENSIVE CONTACTS & S.R.

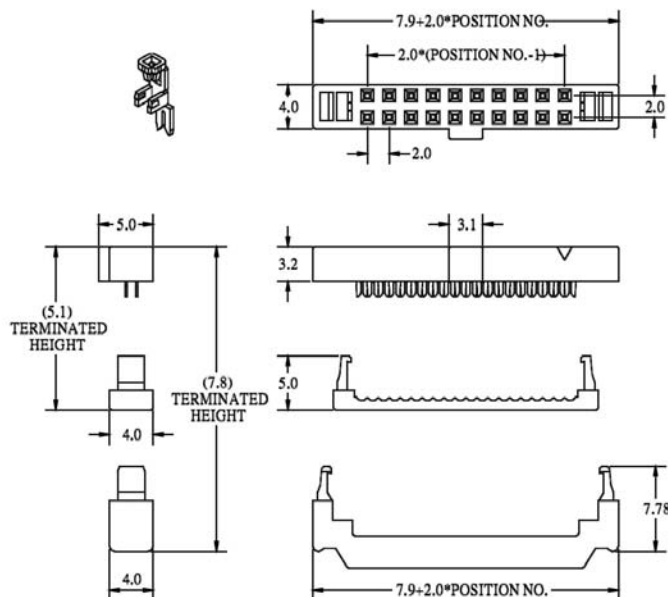

NO. OF CONTACTS:
006, 008, 010, 012, 014,
016, 020, 022, 024, 026,
030, 034, 036, 040, 044,
050

ORDERING INFORMATION:

P/N **K** **x x x x x x** - **x x** **C M B**

1 2 3 4

1. CONSTRUCTION TYPE:
2FV, 2FW, 2FX, 2FY
2. NO. OF CONTACTS:
006~050
3. LENGTH IN CM (CENTIMETERS)
4. COLOR OF TWO IDC CONNECTORS:
"B" BLACK

NOTE: IDC SOCKET CAN'T BE SUPPLIED ALONE.

1.00MM PITCH FLAT CABLE WITH 2* 2.00MM IDC SOCKETS (H=11.4MM) (C7)

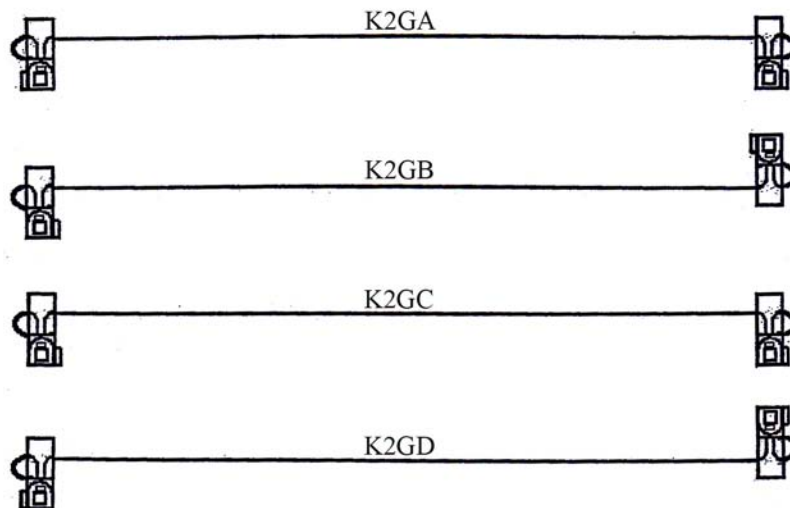

2.00MM PITCH IDC SOCKET WITH HOOKY TERMINATIONS & S.R.

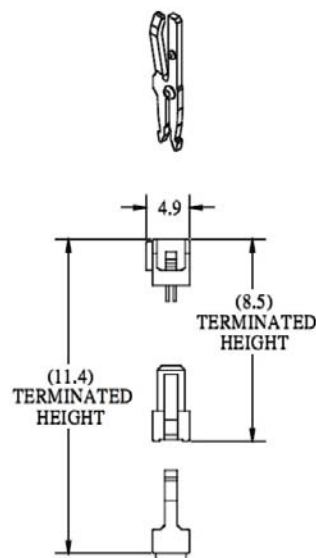
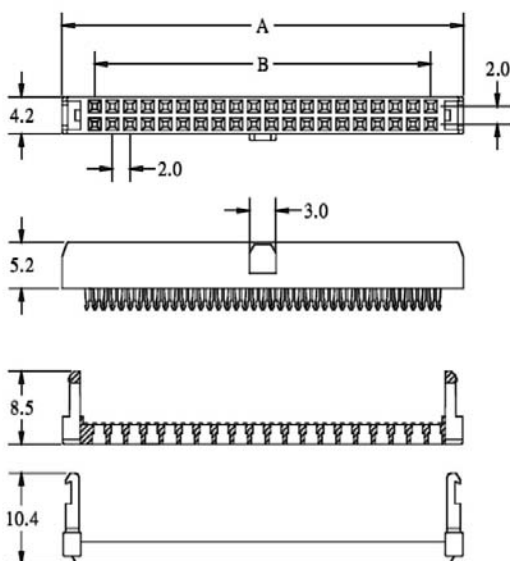

$$A=B+7.20$$

$$B=2.00*\text{POSITIONS}/2-2.00$$

NO. OF CONTACTS:
 006, 008, 010, 012, 014,
 016, 018, 020, 022, 024,
 026, 030, 032, 034, 036,
 038, 040, 044, 048, 050,
 056, 060, 064, 068

ORDERING INFORMATION:

P/N **K** **x x x x x x** - **x x** **C M B**

1 2 3 4

1. CONSTRUCTION TYPE:
2GA, 2GB, 2GC, 2GD
2. NO. OF CONTACTS:
006~068
3. LENGTH IN CM (CENTIMETERS)
4. COLOR OF TWO IDC CONNECTORS:
"B" BLACK

NOTE: IDC SOCKET CAN'T BE SUPPLIED ALONE.

1.00MM PITCH FLAT CABLE WITH 2* 2.00MM IDC SOCKETS (H=11.4MM) (C8)

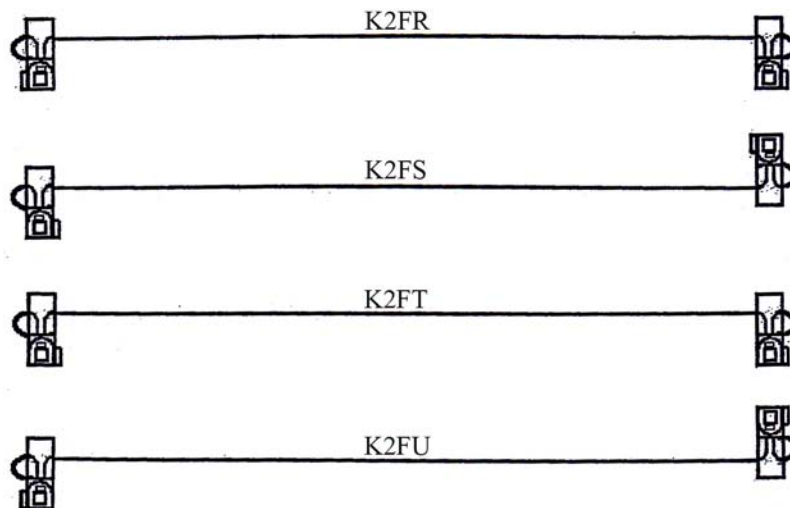

2.00MM PITCH IDC SOCKET WITH S.R. ECONOMICAL TYPE

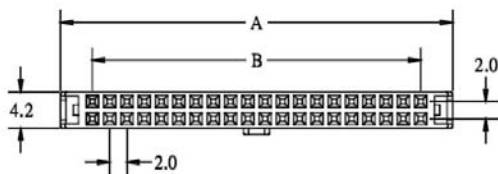

$$A=B+7.20$$

$$B=2.00*\text{POSITIONS}/2-2.00$$

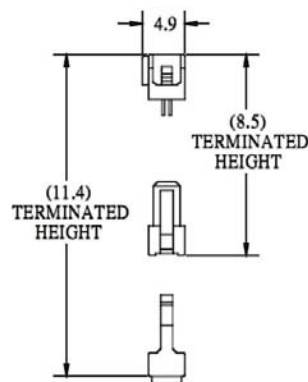
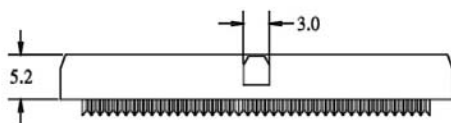

NO. OF CONTACTS:

006, 008, 010, 012, 014,
016, 018, 020, 022, 024,
026, 030, 032, 034, 036,
038, 040, 044, 048, 050,
056, 060, 064, 068

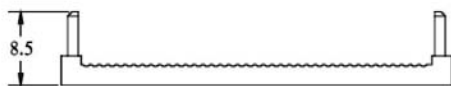

ORDERING INFORMATION:

P/N **K** **x x x x x x** - **x x** **C M B**

1. CONSTRUCTION TYPE:
2FR, 2FS, 2FT, 2FU
2. NO. OF CONTACTS:
006~068
3. LENGTH IN CM (CENTIMETERS)
4. COLOR OF TWO IDC CONNECTORS:
"B" BLACK

NOTE: IDC SOCKET CAN'T BE SUPPLIED ALONE.

1.00MM PITCH FLAT CABLE WITH 2* 2.00MM IDC SOCKETS (H=14.0MM) (C9)

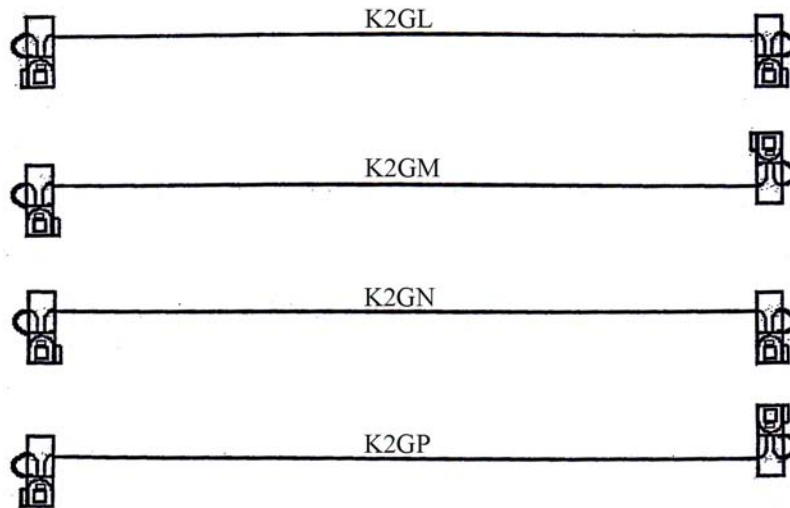

2.00MM PITCH IDC SOCKET WITH RAMP LOCKING & S.R.

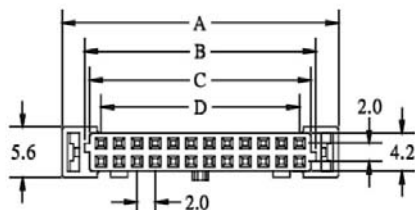

$$A = D + 8.65$$

$$B = D + 3.65$$

$$C = D + 2.55$$

$$D = 2.00 * \text{POSITIONS} / 2 - 2.00$$

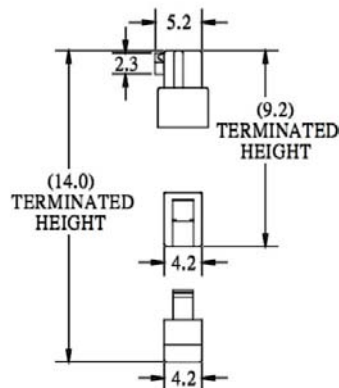
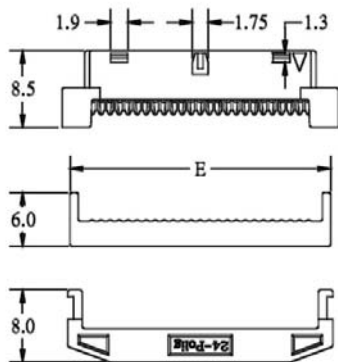

NO. OF CONTACTS:
010, 012, 014, 016, 020,
022, 024, 026, 030, 034,
040, 044, 050, 068

ORDERING INFORMATION:

P/N **K** **x x x x x x** - **x x** **C M B**

1. CONSTRUCTION TYPE:
2GL, 2GM, 2GN, 2GP
2. NO. OF CONTACTS:
010~068
3. LENGTH IN CM (CENTIMETERS)
4. COLOR OF TWO IDC CONNECTORS:
"B" BLACK

NOTE: IDC SOCKET CAN'T BE SUPPLIED ALONE.

**1.00MM PITCH FLAT CABLE WITH
2* 2.00MM PITCH IDC SOCKETS W/O NOSE & WITH STRAIN RELIEFS (H=13.0MM) (D1)**

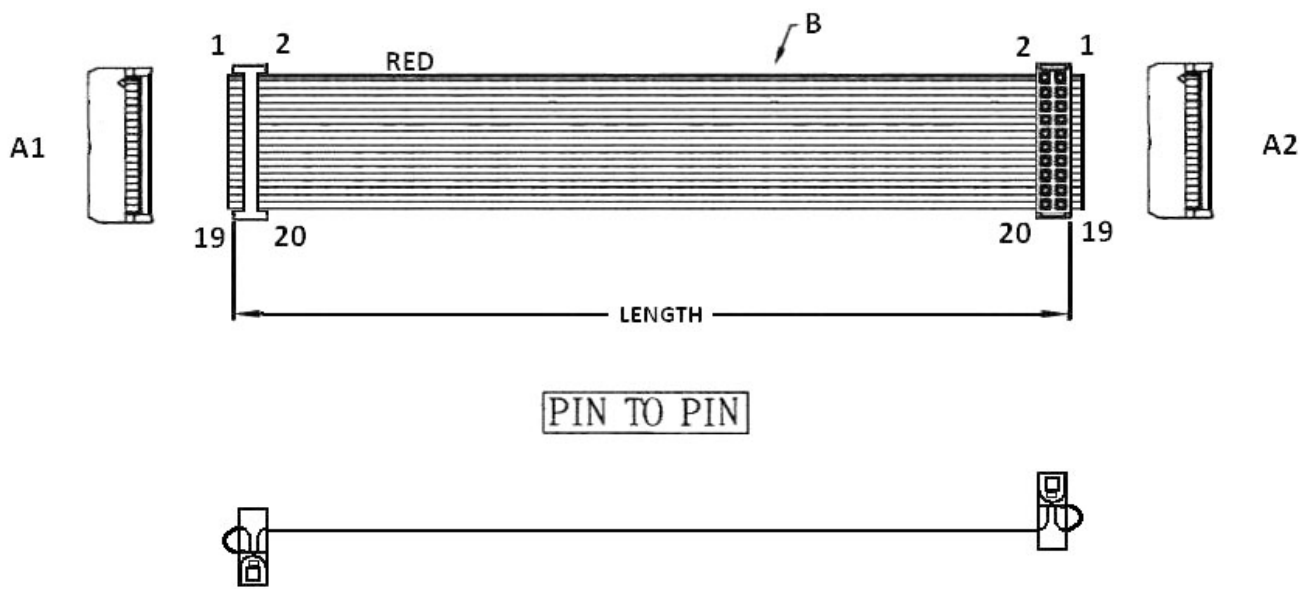

ORDERING INFORMATION:

P/N $\frac{\text{KB}}{1}$ $\frac{\text{xx}}{2}$ $\frac{\text{QQ}}{3}$ - $\frac{\text{xx}}{4}$ **CM** $\frac{\text{B}}{5}$

1. FLAT CABLE TYPE:
"KB" 1.00MM AWG28 UL2651 VW-1
PVC INSULATION GRAY
2. NO. OF CONTACTS:
06~68
3. CONNECTORS AT TWO ENDS:
"QQ" 2.00MM IDC SOCKET W/O NOSE & WITH S.R.
TO 2.00MM IDC SOCKET W/O NOSE & WITH S.R.
4. LENGTH IN CM (CENTIMETERS)
5. COLOR OF TWO IDC CONNECTORS:
"B" BLACK

**1.00MM PITCH FLAT CABLE WITH
2* 2.00MM PITCH IDC SOCKETS W/O NOSE & WITH STRAIN RELIEFS (H=13.0MM) (D2)**

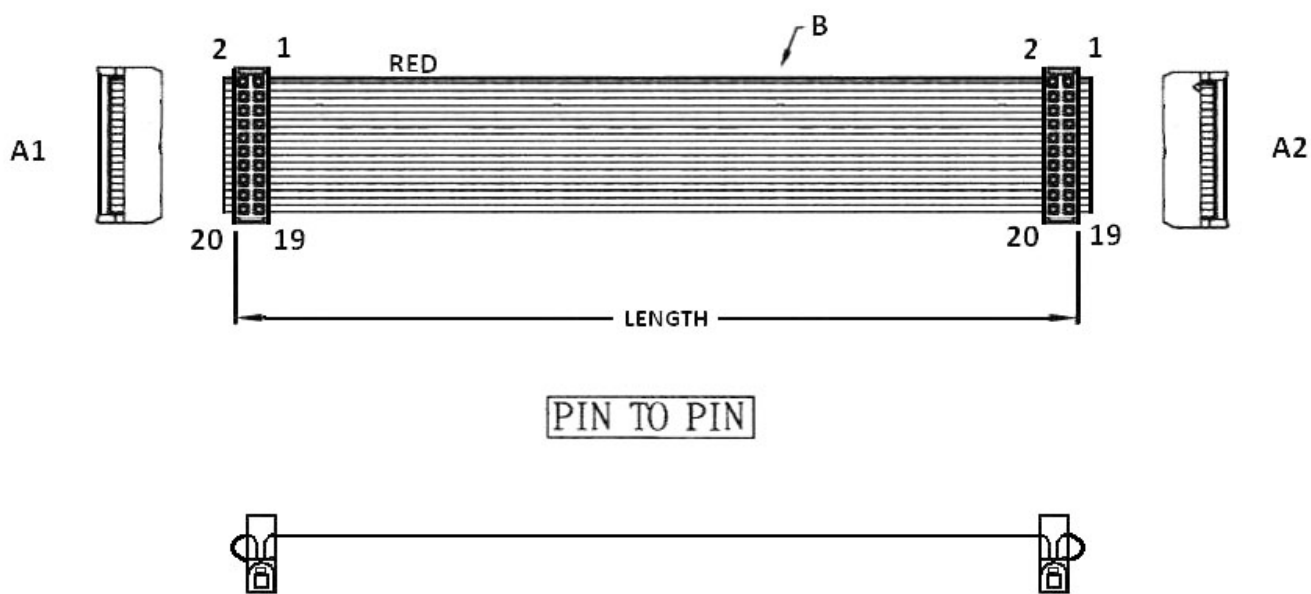

ORDERING INFORMATION:

P/N $\frac{\text{KB}}{1}$ $\frac{\text{xx}}{2}$ $\frac{\text{QR}}{3}$ - $\frac{\text{xx}}{4}$ **CM** $\frac{\text{B}}{5}$

1. FLAT CABLE TYPE:
"KB" 1.00MM AWG28 UL2651 VW-1
PVC INSULATION GRAY
2. NO. OF CONTACTS:
06~68
3. CONNECTORS AT TWO ENDS:
"QR" 2.00MM IDC SOCKET W/O NOSE & WITH S.R.
TO 2.00MM IDC SOCKET W/O NOSE & WITH S.R.
4. LENGTH IN CM (CENTIMETERS)
5. COLOR OF TWO IDC CONNECTORS:
"B" BLACK

**1.00MM PITCH FLAT CABLE WITH
2* 2.00MM PITCH IDC SOCKETS W/O NOSE & WITH STRAIN RELIEFS (H=13.00MM) (D3)**

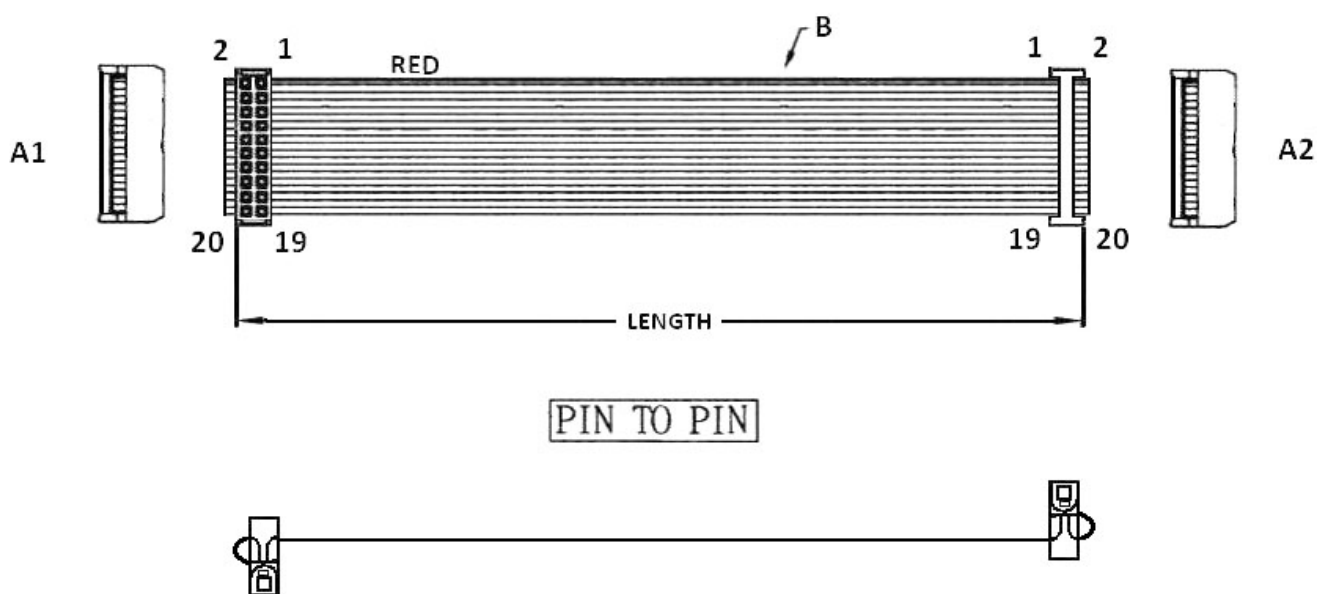

ORDERING INFORMATION:

P/N $\frac{\text{KB}}{1}$ $\frac{\text{xx}}{2}$ $\frac{\text{RR}}{3}$ - $\frac{\text{xx}}{4}$ **CM** $\frac{\text{B}}{5}$

1. FLAT CABLE TYPE:
"KB" 1.00MM AWG28 UL2651 VW-1
PVC INSULATION GRAY
2. NO. OF CONTACTS:
06~68
3. CONNECTORS AT TWO ENDS:
"RR" 2.00MM IDC SOCKET W/O NOSE & WITH S.R.
TO 2.00MM IDC SOCKET W/O NOSE & WITH S.R.
4. LENGTH IN CM (CENTIMETERS)
5. COLOR OF TWO IDC CONNECTORS:
"B" BLACK

**1.00MM PITCH FLAT CABLE WITH
2* 2.00MM IDC SOCKETS WITH STAINLESS CABLE LOCK & W/O NOSE (H=9.8MM) (D4)**

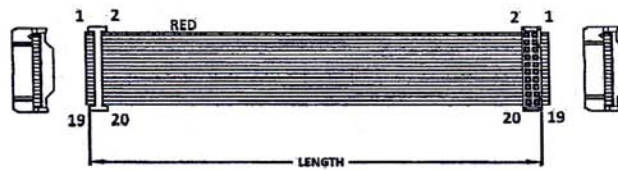
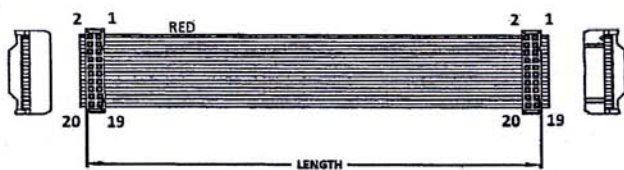

ORDERING INFORMATION:

P/N K 1 2 3 4 - 3 4 C M B

1. CONSTRUCTION TYPE:
2FA, 2FB, 2FC
2. NO. OF CONTACTS:
008~050
3. LENGTH IN CM (CENTIMETERS)
4. COLOR OF TWO IDC CONNECTORS:
"B" BLACK

1.00MM PITCH FLAT CABLE WITH 2.00MM 44 PIN IDC SOCKETS

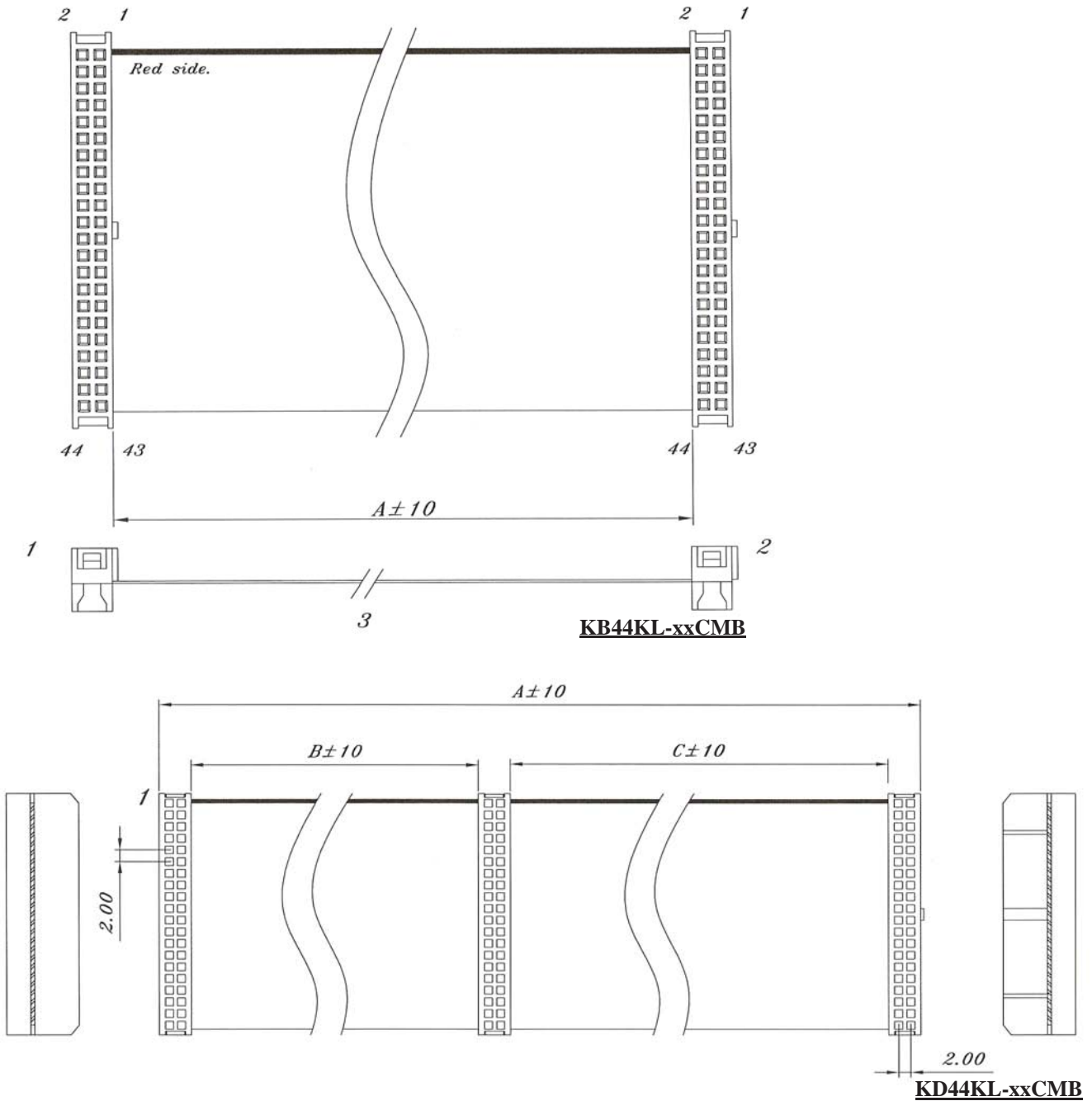

ORDERING INFORMATION:

P/N K B 4 4 K L - x x C M B

FLAT CABLE 2*2.00MM 44 PIN IDC SOCKETS WITH 2 POLARIZATION NOSES
A= LENGTH IN CM

P/N K D 4 4 K L - x x C M B

FLAT CABLE 3*2.00MM 44 PIN IDC SOCKETS IN WHICH 2 SOCKETS WITHOUT POLARIZATION NOSES
AND 1 SOCKET WITH POLARIZATION NOSE, A= LENGTH IN CM