

## 1.00MM PITCH FLAT CABLE WITH 2.00MM IDC SOCKET (H=5.1MM & 7.8MM) TO BOX HEADER IDC TYPE (STANDARD)

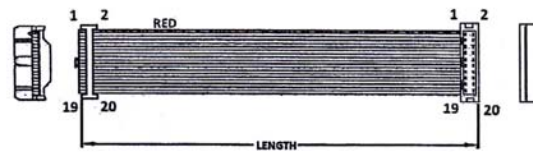

## 2.00MM PITCH BOX HEADER IDC TYPE (STANDARD)

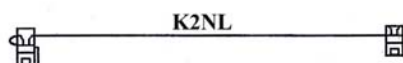
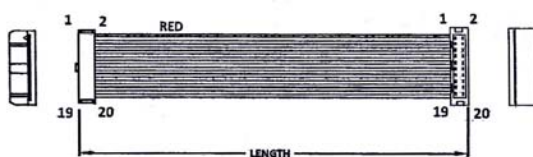
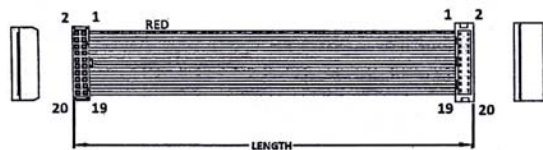
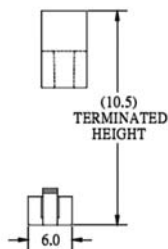
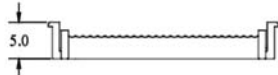
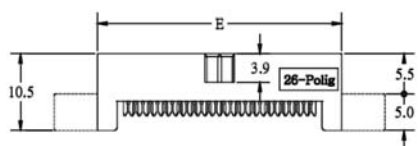
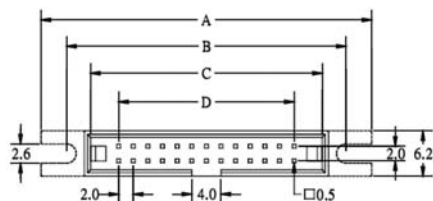

POSITION	A	B	C	D	E
6	25.24	18.24	11.70	4.00	13.40
8	27.24	20.24	13.70	6.00	15.40
10	29.24	22.24	15.70	8.00	17.40
12	31.24	24.24	17.70	10.00	19.40
14	33.24	26.24	19.70	12.00	21.40
16	35.24	28.24	21.70	14.00	23.40
20	39.24	32.24	25.70	18.00	27.40
22	41.24	34.24	27.70	20.00	29.40
24	43.24	36.24	29.70	22.00	31.40
26	45.24	38.24	31.70	24.00	33.40
30	49.24	42.24	35.70	28.00	37.40
34	53.24	46.24	39.70	32.00	41.40
40	59.24	52.24	45.70	38.00	47.40
44	63.24	56.24	49.70	42.00	51.40
50	69.24	62.24	55.70	48.00	57.40
68	87.24	80.24	73.70	66.00	75.40

## ORDERING INFORMATION:

P/N **K** **x x x x x x** - **x x** **C M D**

1                      2                      3                      4

- CONSTRUCTION TYPE:  
IDC SOCKET W/O S.R. : 2NJ, 2NK (H=5.1MM)  
IDC SOCKET WITH S.R. : 2NL, 2NM (H=7.8MM)
- NO. OF CONTACTS:  
006~068
- LENGTH IN CM (CENTIMETERS)
- COLOR OF TWO IDC CONNECTORS:  
"D" BLACK (SOCKET) + GRAY (HEADER)

## 1.00MM PITCH FLAT CABLE WITH 2.00MM IDC SOCKET (H=5.1MM & 7.8MM) TO BOX HEADER IDC TYPE (SPECIAL I)

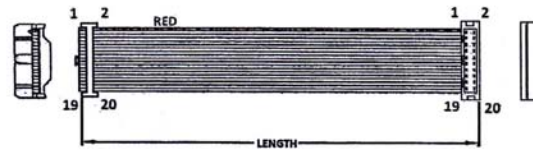
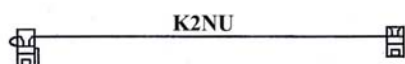
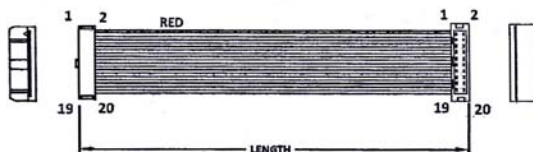

## 2.00MM PITCH BOX HEADER IDC TYPE (SPECIAL I)

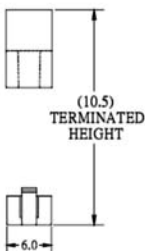
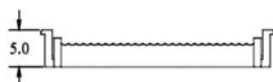
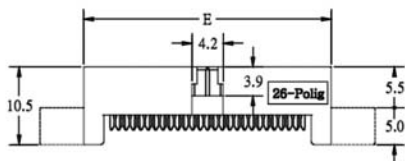
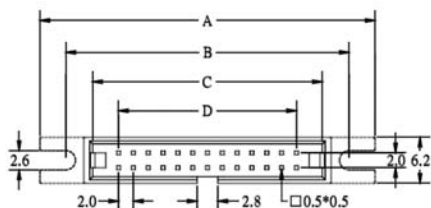

POSITION	A	B	C	D	E
6	25.24	18.24	11.00	4.00	13.40
8	27.24	20.24	13.00	6.00	15.40
10	29.24	22.24	15.00	8.00	17.40
12	31.24	24.24	17.00	10.00	19.40
14	33.24	26.24	19.00	12.00	21.40
16	35.24	28.24	21.00	14.00	23.40
20	39.24	32.24	25.00	18.00	27.40
22	41.24	34.24	27.00	20.00	29.40
24	43.24	36.24	29.00	22.00	31.40
26	45.24	38.24	31.00	24.00	33.40
30	49.24	42.24	35.00	28.00	37.40
34	53.24	46.24	39.00	32.00	41.40
40	59.24	52.24	45.00	38.00	47.40
44	63.24	56.24	49.00	42.00	51.40
50	69.24	62.24	55.00	48.00	57.40
68	87.24	80.24	73.00	66.00	75.40

## ORDERING INFORMATION:

P/N **K** **x x x x x x** - **x x** **C M D**

1            2            3            4

- CONSTRUCTION TYPE:  
IDC SOCKET W/O S.R. : 2NS, 2NT (H=5.1MM)  
IDC SOCKET WITH S.R. : 2NU, 2NV (H=7.8MM)
- NO. OF CONTACTS:  
006~068
- LENGTH IN CM (CENTIMETERS)
- COLOR OF TWO IDC CONNECTORS:  
"D" BLACK (SOCKET) + GRAY (HEADER)

NOTE: MATES WITH FEMALE HEADERS 20051, 20052, 20053 & 20054 SERIES

## 1.00MM PITCH FLAT CABLE WITH 2.00MM IDC SOCKET (H=5.1MM & 7.8MM) TO BOX HEADER IDC TYPE (SPECIAL II)

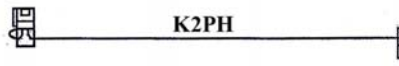
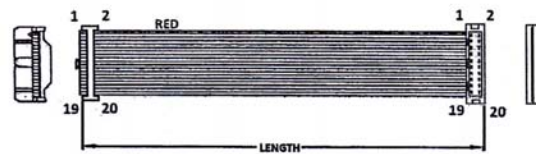
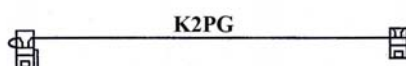
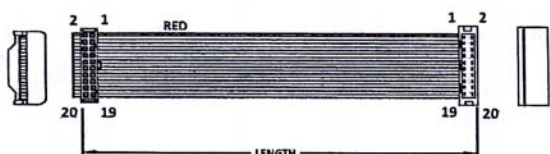
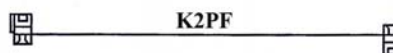
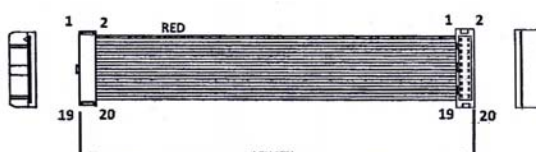
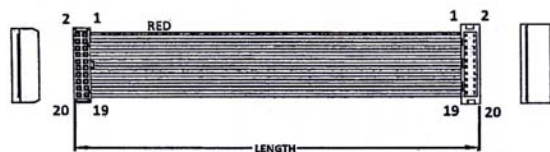

## 2.00MM PITCH BOX HEADER IDC TYPE (SPECIAL II)

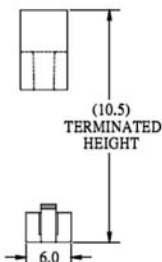
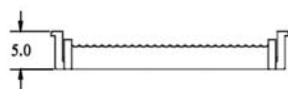
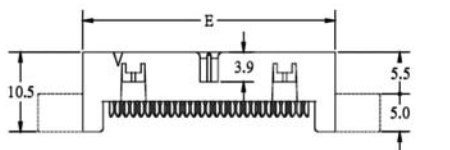
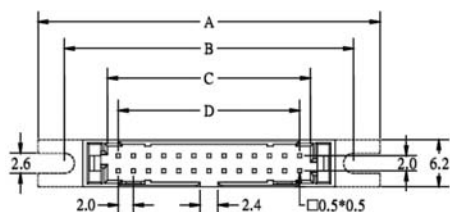

POSITION	A	B	C	D	E
10	29.24	22.24	10.84	8.00	17.40
12	31.24	24.24	12.84	10.00	19.40
14	33.24	26.24	14.84	12.00	21.40
16	35.24	28.24	16.84	14.00	23.40
20	39.24	32.24	20.84	18.00	27.40
22	41.24	34.24	22.84	20.00	29.40
24	43.24	36.24	24.84	22.00	31.40
26	45.24	38.24	26.84	24.00	33.40
30	49.24	42.24	30.84	28.00	37.40
34	53.24	46.24	34.84	32.00	41.40
40	59.24	52.24	40.84	38.00	47.40
44	63.24	56.24	44.84	42.00	51.40
50	69.24	62.24	50.84	48.00	57.40
68	87.24	80.24	68.84	66.00	75.40

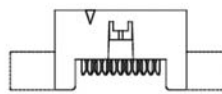

(AVAILABLE FROM 10 TO 12)

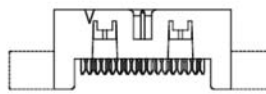

(AVAILABLE FROM 14 TO 68)

## ORDERING INFORMATION:

P/N **K** **x** **x** **x** **x** **x** **x** - **x** **x** **C** **M** **D**

- CONSTRUCTION TYPE:  
IDC SOCKET W/O S.R. : 2PE, 2PF (H=5.1MM)  
IDC SOCKET WITH S.R. : 2PG, 2PH (H=7.8MM)
- NO. OF CONTACTS:  
006~068
- LENGTH IN CM (CENTIMETERS)
- COLOR OF TWO IDC CONNECTORS:  
"D" BLACK (SOCKET) + GRAY (HEADER)

## 1.00MM PITCH FLAT CABLE WITH 2.00MM IDC SOCKET (H=8.5MM & 11.4MM) TO BOX HEADER IDC TYPE (STANDARD)

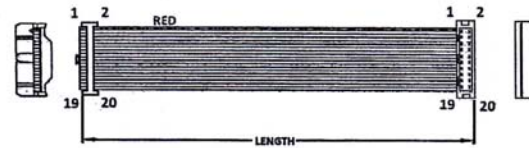
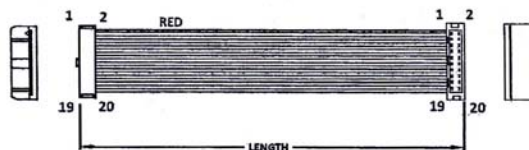
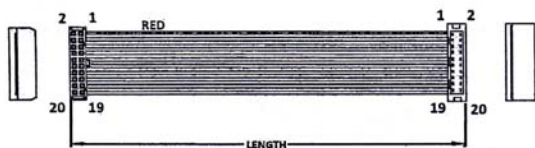

## 2.00MM PITCH BOX HEADER IDC TYPE (STANDARD)

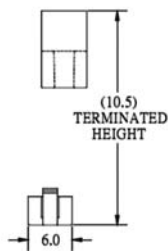
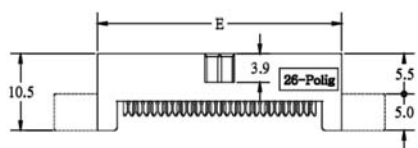
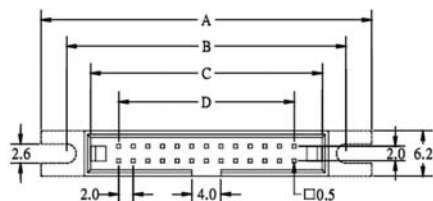

POSITION	A	B	C	D	E
6	25.24	18.24	11.70	4.00	13.40
8	27.24	20.24	13.70	6.00	15.40
10	29.24	22.24	15.70	8.00	17.40
12	31.24	24.24	17.70	10.00	19.40
14	33.24	26.24	19.70	12.00	21.40
16	35.24	28.24	21.70	14.00	23.40
20	39.24	32.24	25.70	18.00	27.40
22	41.24	34.24	27.70	20.00	29.40
24	43.24	36.24	29.70	22.00	31.40
26	45.24	38.24	31.70	24.00	33.40
30	49.24	42.24	35.70	28.00	37.40
34	53.24	46.24	39.70	32.00	41.40
40	59.24	52.24	45.70	38.00	47.40
44	63.24	56.24	49.70	42.00	51.40
50	69.24	62.24	55.70	48.00	57.40
68	87.24	80.24	73.70	66.00	75.40

## ORDERING INFORMATION:

P/N  $\frac{K}{1} \frac{x x x x x x}{2} - \frac{x x}{3} \frac{C M D}{4}$

- CONSTRUCTION TYPE:  
IDC SOCKET W/O S.R. : 2NE, 2NF (H=8.5MM)  
IDC SOCKET WITH S.R. : 2NG, 2NH (H=11.4MM)
- NO. OF CONTACTS:  
006~068
- LENGTH IN CM (CENTIMETERS)
- COLOR OF TWO IDC CONNECTORS:  
"D" BLACK (SOCKET) + GRAY (HEADER)

# 1.00MM PITCH FLAT CABLE WITH 2.00MM IDC SOCKET (H=8.5MM & 11.4MM) TO BOX HEADER IDC TYPE (SPECIAL I)

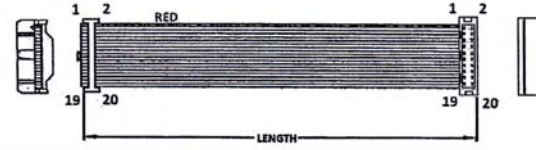
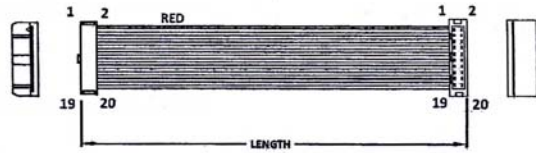
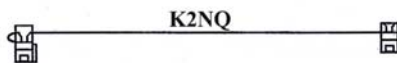
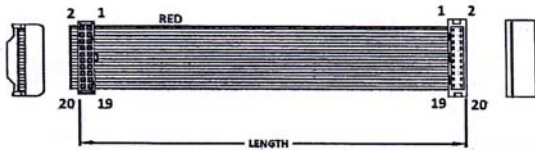
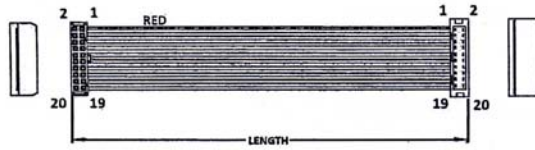

## 2.00MM PITCH BOX HEADER IDC TYPE (SPECIAL I)

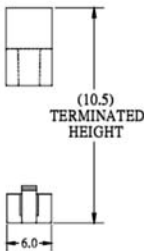
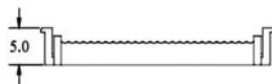
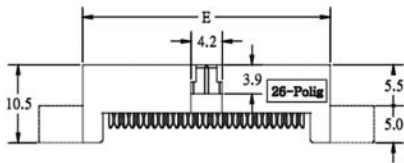
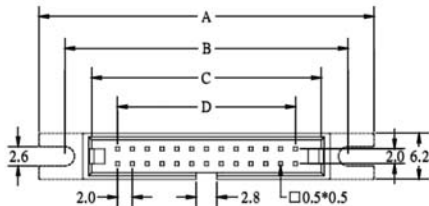

POSITION	A	B	C	D	E
6	25.24	18.24	11.00	4.00	13.40
8	27.24	20.24	13.00	6.00	15.40
10	29.24	22.24	15.00	8.00	17.40
12	31.24	24.24	17.00	10.00	19.40
14	33.24	26.24	19.00	12.00	21.40
16	35.24	28.24	21.00	14.00	23.40
20	39.24	32.24	25.00	18.00	27.40
22	41.24	34.24	27.00	20.00	29.40
24	43.24	36.24	29.00	22.00	31.40
26	45.24	38.24	31.00	24.00	33.40
30	49.24	42.24	35.00	28.00	37.40
34	53.24	46.24	39.00	32.00	41.40
40	59.24	52.24	45.00	38.00	47.40
44	63.24	56.24	49.00	42.00	51.40
50	69.24	62.24	55.00	48.00	57.40
68	87.24	80.24	73.00	66.00	75.40

## ORDERING INFORMATION:

P/N **K** 1 2 3 4 **C M D**

- CONSTRUCTION TYPE:  
IDC SOCKET W/O S.R. : 2NN, 2NP (H=8.5MM)  
IDC SOCKET WITH S.R. : 2NQ, 2NR (H=11.4MM)
- NO. OF CONTACTS:  
006~068
- LENGTH IN CM (CENTIMETERS)
- COLOR OF TWO IDC CONNECTORS:  
"D" BLACK (SOCKET) + GRAY (HEADER)

NOTE: MATES WITH FEMALE HEADERS 20051, 20052, 20053 & 20054 SERIES

# 1.00MM PITCH FLAT CABLE WITH 2.00MM IDC SOCKET (H=8.5MM & 11.4MM) TO BOX HEADER IDC TYPE (SPECIAL II)

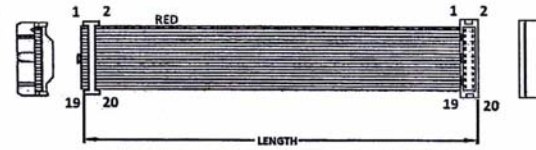
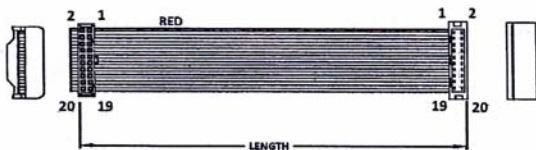
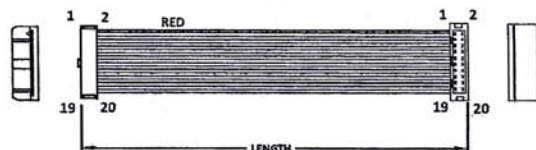
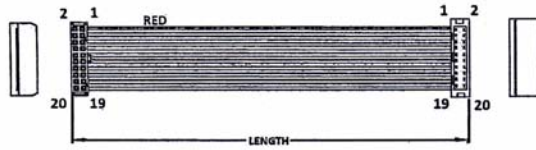

## 2.00MM PITCH BOX HEADER IDC TYPE (SPECIAL II)

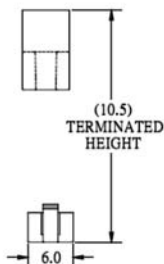
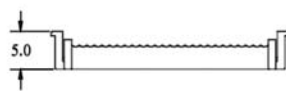
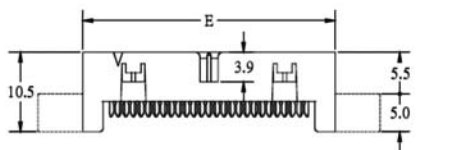
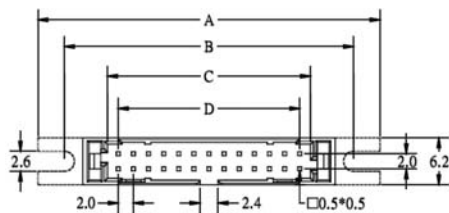

POSITION	A	B	C	D	E
10	29.24	22.24	10.84	8.00	17.40
12	31.24	24.24	12.84	10.00	19.40
14	33.24	26.24	14.84	12.00	21.40
16	35.24	28.24	16.84	14.00	23.40
20	39.24	32.24	20.84	18.00	27.40
22	41.24	34.24	22.84	20.00	29.40
24	43.24	36.24	24.84	22.00	31.40
26	45.24	38.24	26.84	24.00	33.40
30	49.24	42.24	30.84	28.00	37.40
34	53.24	46.24	34.84	32.00	41.40
40	59.24	52.24	40.84	38.00	47.40
44	63.24	56.24	44.84	42.00	51.40
50	69.24	62.24	50.84	48.00	57.40
68	87.24	80.24	68.84	66.00	75.40

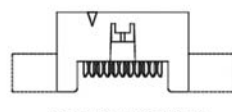

(AVAILABLE FROM 10 TO 12)

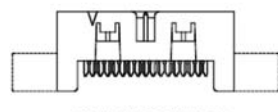

(AVAILABLE FROM 14 TO 68)

## ORDERING INFORMATION:

P/N **K** **x** **x** **x** **x** **x** **x** - **x** **x** **C** **M** **D**

- CONSTRUCTION TYPE:  
IDC SOCKET W/O S.R. : 2PA, 2PB (H=8.5MM)  
IDC SOCKET WITH S.R. : 2PC, 2PD (H=11.4MM)
- NO. OF CONTACTS:  
006~068
- LENGTH IN CM (CENTIMETERS)
- COLOR OF TWO IDC CONNECTORS:  
"D" BLACK (SOCKET) + GRAY (HEADER)

**1.00MM PITCH FLAT CABLE WITH 2.00MM IDC SOCKET (H=8.5MM)  
TO IDC TYPE BOX HEADER WITH EARS (K1)**

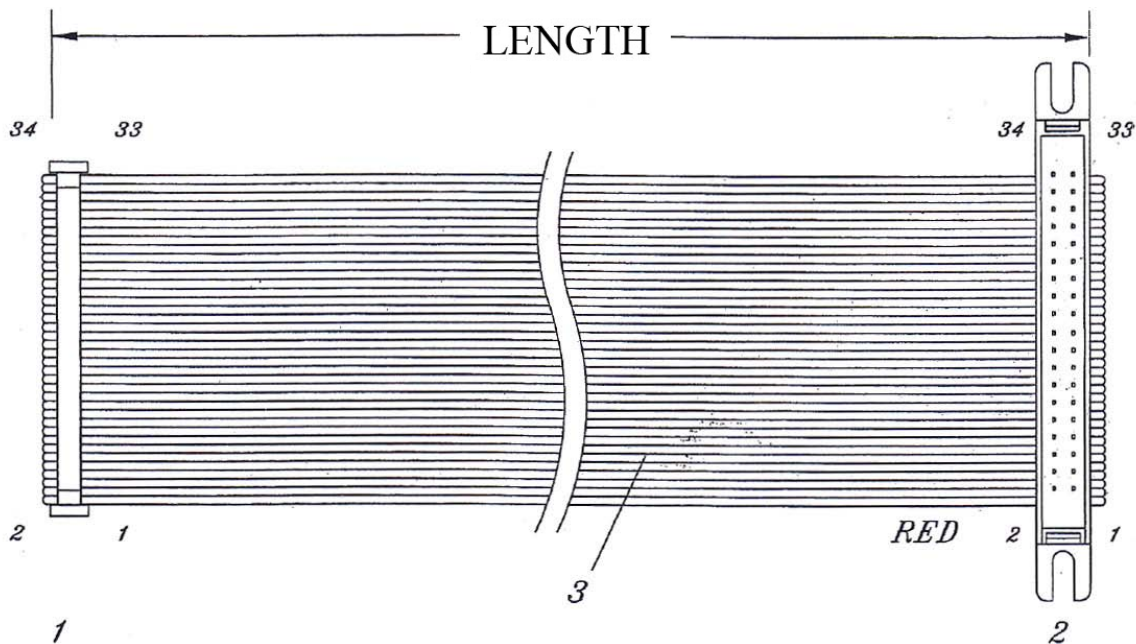

**2.00MM PITCH IDC TYPE BOX HEADER WITH EARS (TYPE 1)**

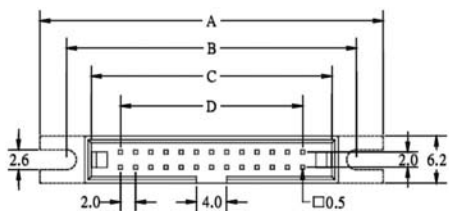

$$A = D + 21.24$$

$$B = D + 14.24$$

$$C = D + 7.70$$

$$D = 2.00 * \text{POSITIONS} / 2 - 2.00$$

$$E = D + 9.40$$

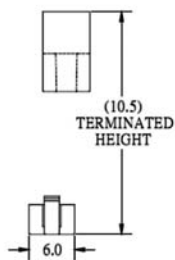
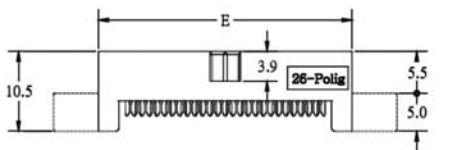

NO. OF CONTACTS:  
006, 008, 010, 012, 014,  
016, 020, 022, 024, 026,  
030, 034, 040, 044, 050,  
068

**ORDERING INFORMATION:**

**P/N** K 1 2 3 4 C M D

1. CONSTRUCTION TYPE:  
2PU
2. NO. OF CONTACTS:  
006~068
3. LENGTH IN CM (CENTIMETERS)
4. COLOR OF TWO IDC CONNECTORS:  
"D" BLACK(SOCKET)+GRAY(HEADER)

**1.00MM PITCH FLAT CABLE WITH 2.00MM IDC SOCKET (H=8.5MM)  
TO IDC TYPE BOX HEADER WITH EARS (K2)**

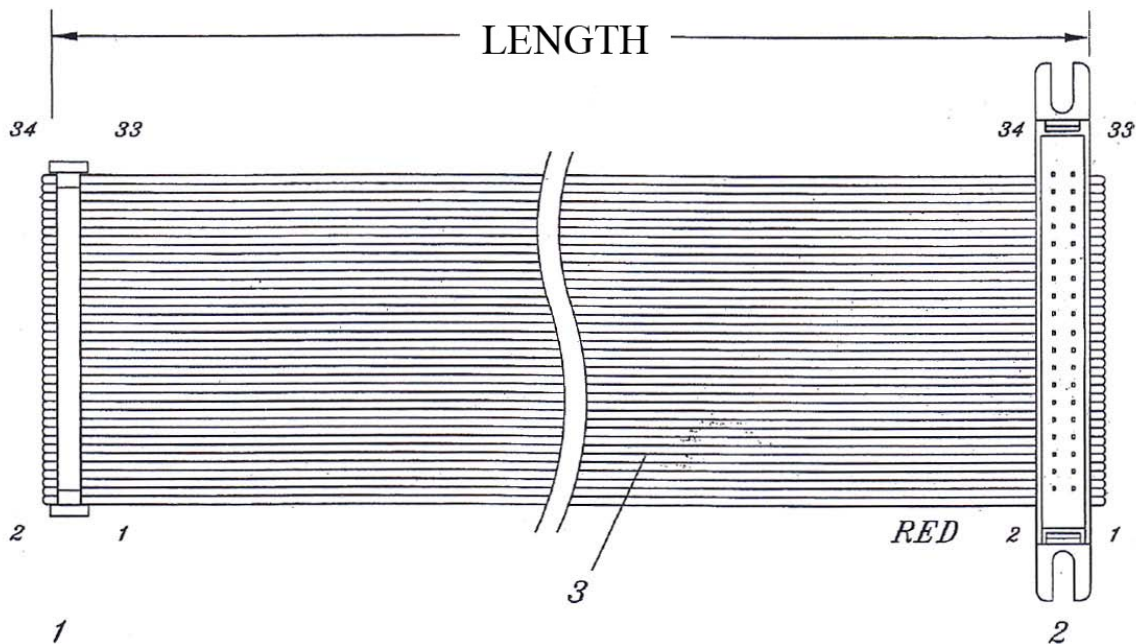

**2.00MM PITCH IDC TYPE BOX HEADER WITH EARS (TYPE 2)**

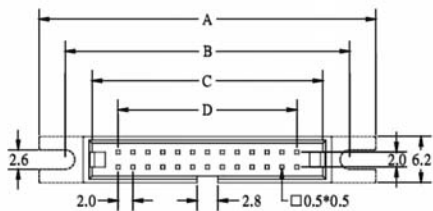

$$A = D + 21.24$$

$$B = D + 14.24$$

$$C = D + 7.70$$

$$D = 2.00 * \text{POSITIONS} / 2 - 2.00$$

$$E = D + 9.40$$

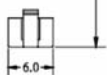
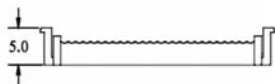
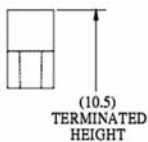
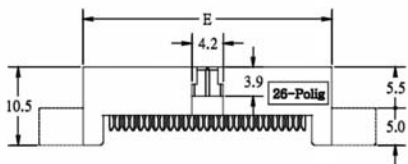

NO. OF CONTACTS:  
006, 008, 010, 012, 014,  
016, 020, 022, 024, 026,  
030, 034, 040, 044, 050,  
068

**ORDERING INFORMATION:**

**P/N** K 1 2 3 4 **C M D**

1. CONSTRUCTION TYPE:  
2PV
2. NO. OF CONTACTS:  
006~068
3. LENGTH IN CM (CENTIMETERS)
4. COLOR OF TWO IDC CONNECTORS:  
"D" BLACK(SOCKET)+GRAY(HEADER)

NOTE: MATES WITH FEMALE HEADERS 20051, 20052, 20053 & 20054 SERIES



**1.00MM PITCH FLAT CABLE WITH 2.00MM IDC SOCKET (H=5.1MM)  
TO IDC TYPE BOX HEADER WITH EARS (K3)**

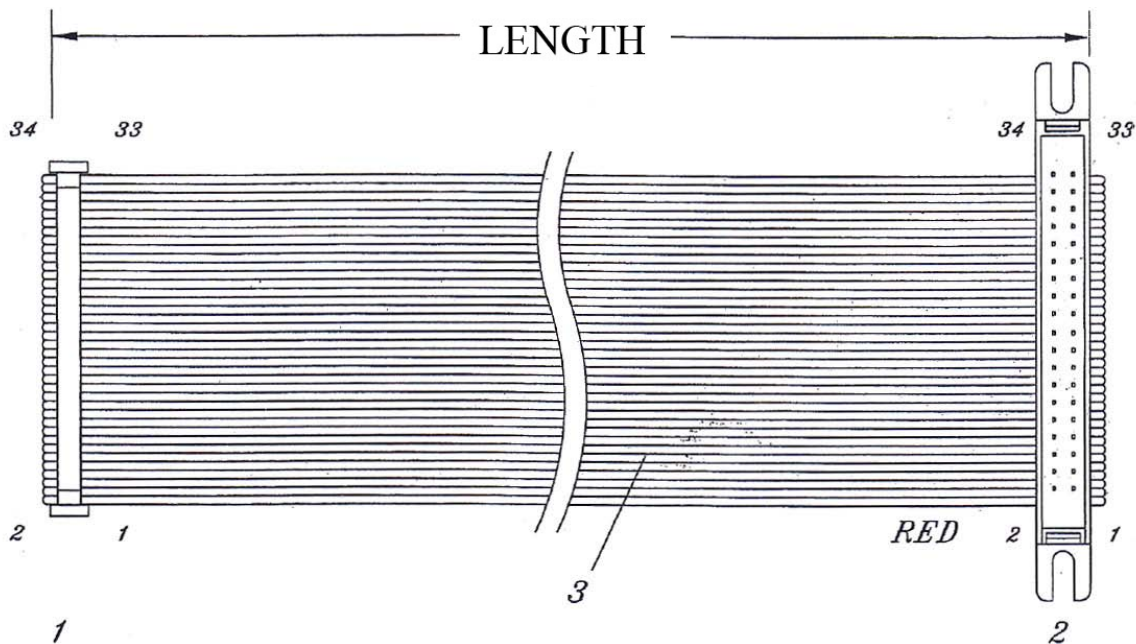

**2.00MM PITCH IDC TYPE BOX HEADER WITH EARS (TYPE 1)**

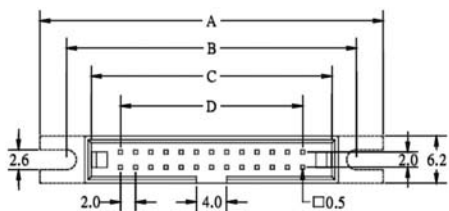

$$A = D + 21.24$$

$$B = D + 14.24$$

$$C = D + 7.70$$

$$D = 2.00 * \text{POSITIONS} / 2 - 2.00$$

$$E = D + 9.40$$

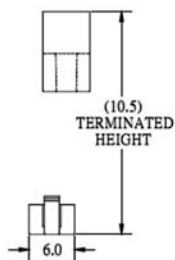
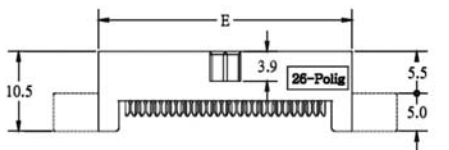

NO. OF CONTACTS:  
006, 008, 010, 012, 014,  
016, 020, 022, 024, 026,  
030, 034, 040, 044, 050,  
068

**ORDERING INFORMATION:**

**P/N** K 1 2 3 4 C M D

1. CONSTRUCTION TYPE:  
2PW
2. NO. OF CONTACTS:  
006~068
3. LENGTH IN CM (CENTIMETERS)
4. COLOR OF TWO IDC CONNECTORS:  
"D" BLACK(SOCKET)+GRAY(HEADER)

**1.00MM PITCH FLAT CABLE WITH 2.00MM IDC SOCKET (H=5.1MM)  
TO IDC TYPE BOX HEADER WITH EARS (K4)**

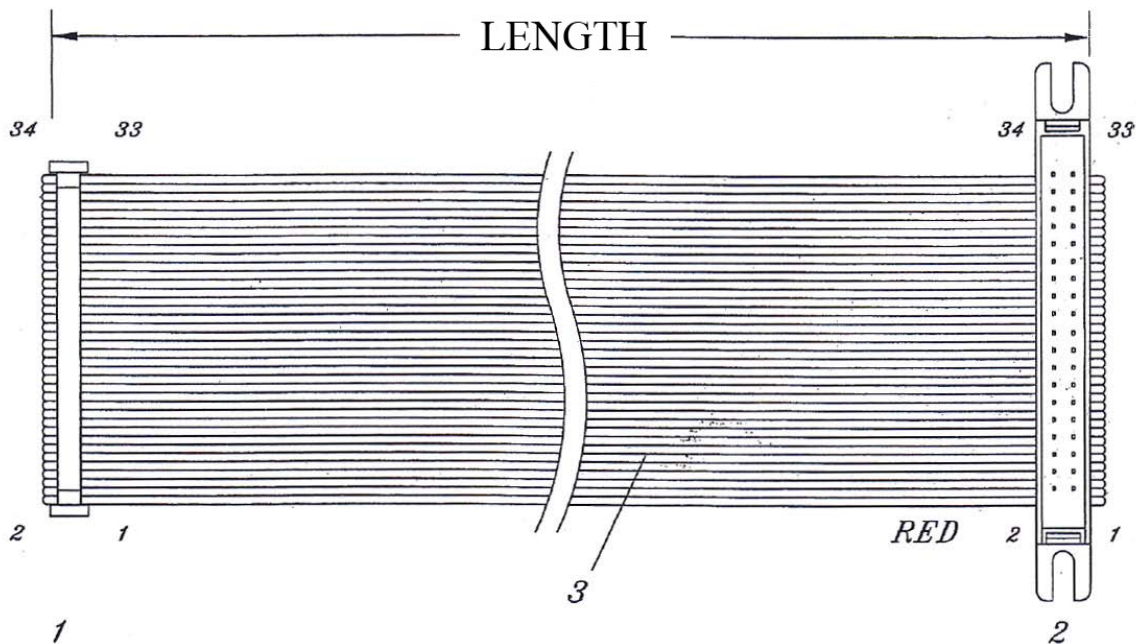

**2.00MM PITCH IDC TYPE BOX HEADER WITH EARS (TYPE 2)**

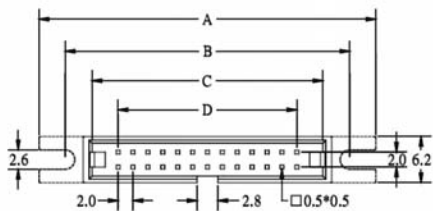

$$A = D + 21.24$$

$$B = D + 14.24$$

$$C = D + 7.70$$

$$D = 2.00 * \text{POSITIONS} / 2 - 2.00$$

$$E = D + 9.40$$

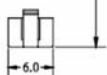
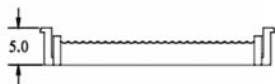
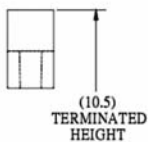
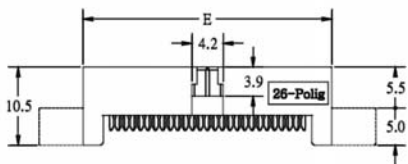

NO. OF CONTACTS:  
006, 008, 010, 012, 014,  
016, 020, 022, 024, 026,  
030, 034, 040, 044, 050,  
068

**ORDERING INFORMATION:**

**P/N** K 1 2 3 4 **C M D**

1. CONSTRUCTION TYPE:  
2PX
2. NO. OF CONTACTS:  
006~068
3. LENGTH IN CM (CENTIMETERS)
4. COLOR OF TWO IDC CONNECTORS:  
"D" BLACK(SOCKET)+GRAY(HEADER)

NOTE: MATES WITH FEMALE HEADERS 20051, 20052, 20053 & 20054 SERIES

## 1.00MM PITCH FLAT CABLE WITH 2\*2.00MM IDC TYPE BOX HEADERS (L1)

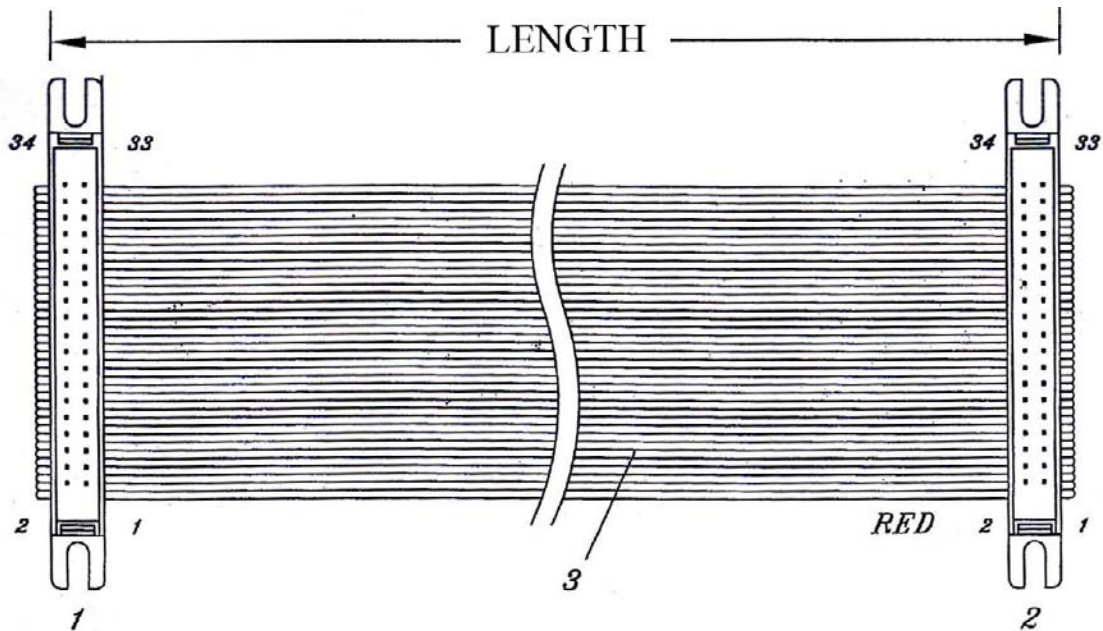

### 1.00MM PITCH BOX HEADER IDC TYPE WITH EARS (TYPE1)

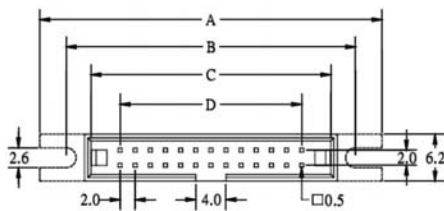

$$A = D + 21.24$$

$$B = D + 14.24$$

$$C = D + 7.70$$

$$D = 2.00 * \text{POSITIONS} / 2 - 2.00$$

$$E = D + 9.40$$

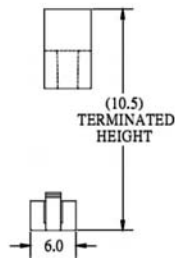
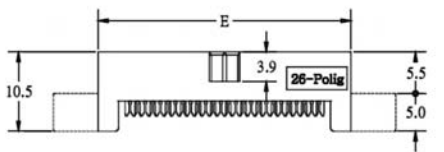

NO. OF CONTACTS:  
006, 008, 010, 012, 014,  
016, 020, 022, 024, 026,  
030, 034, 040, 044, 050,  
068

### ORDERING INFORMATION:

P/N K 1 2 3 4 C M A

1. CONSTRUCTION TYPE:  
2PS
2. NO. OF CONTACTS:  
006~068
3. LENGTH IN CM (CENTIMETERS)
4. COLOR OF TWO IDC CONNECTORS:  
"A" GRAY

## 1.00MM PITCH FLAT CABLE WITH 2\*2.00MM IDC TYPE BOX HEADERS (L2)

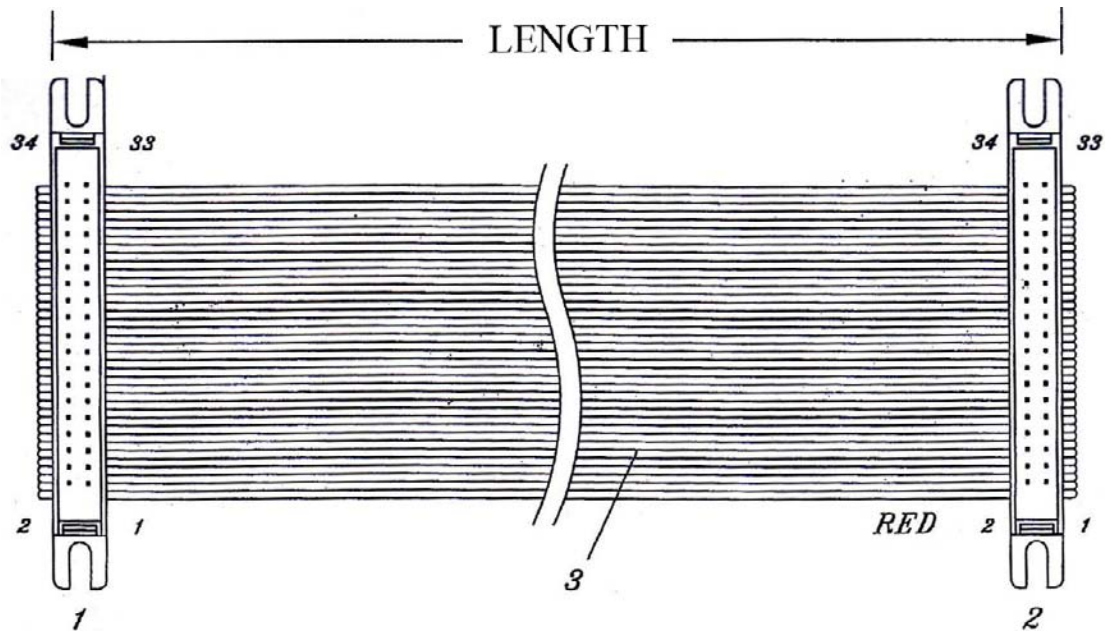

### 1.00MM PITCH BOX HEADER IDC TYPE WITH EARS (TYPE2)

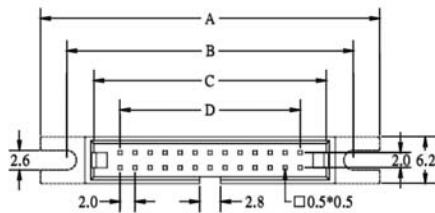

$$A = D + 21.24$$

$$B = D + 14.24$$

$$C = D + 7.70$$

$$D = 2.00 * \text{POSITIONS} / 2 - 2.00$$

$$E = D + 9.40$$

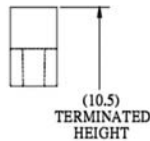
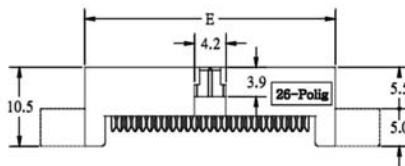

NO. OF CONTACTS:  
006, 008, 010, 012, 014,  
016, 020, 022, 024, 026,  
030, 034, 040, 044, 050,  
068

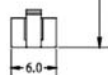
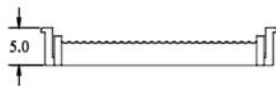

### ORDERING INFORMATION:

P/N  $\frac{K}{1} \frac{x x x x x x}{2} - \frac{x x}{3} \frac{C M A}{4}$

1. CONSTRUCTION TYPE:  
2PT
2. NO. OF CONTACTS:  
006~068
3. LENGTH IN CM (CENTIMETERS)
4. COLOR OF TWO IDC CONNECTORS:  
"A" GRAY

NOTE1: BOX HEADER CAN'T BE SUPPLIED ALONE.

NOTE2: MATES WITH FEMALE HEADERS 20051, 20052, 20053 & 20054 SERIES

**1.00MM PITCH FLAT CABLE WITH 2.00MM IDC SOCKET W/O S.R. (H=5.1MM)  
TO IDC PLUG WITH SHORT LATCHES (M1)**

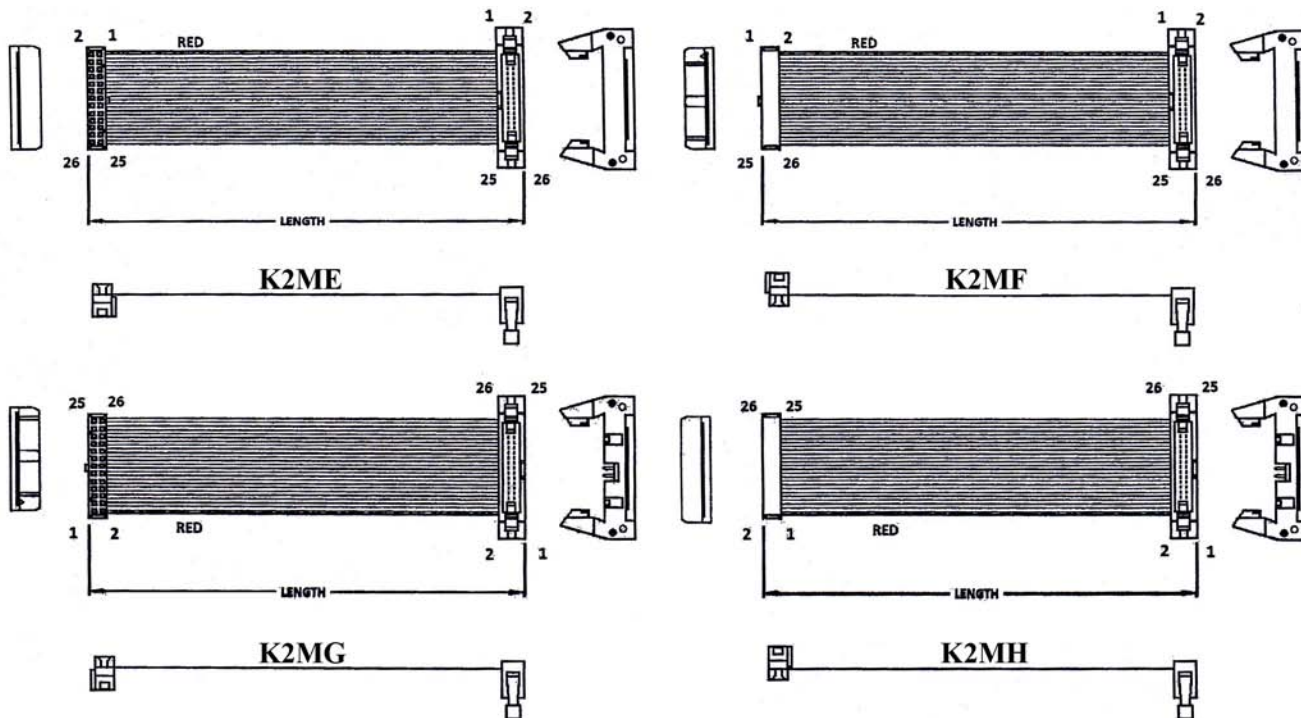

**ORDERING INFORMATION:**

**P/N K 1 2 3 4**

1. CONSTRUCTION TYPE:  
2ME, 2MF, 2MG, 2MH
2. NO. OF CONTACTS:  
010~050
3. LENGTH IN CM (CENTIMETERS)
4. COLOR OF TWO IDC CONNECTORS:  
"D" BLACK(SOCKET)+GRAY(HEADER)

**1.00MM PITCH FLAT CABLE WITH 2.00MM IDC SOCKET W/O NOSE (H=7.4MM)  
TO IDC PLUG WITH SHORT LATCHES (M2)**

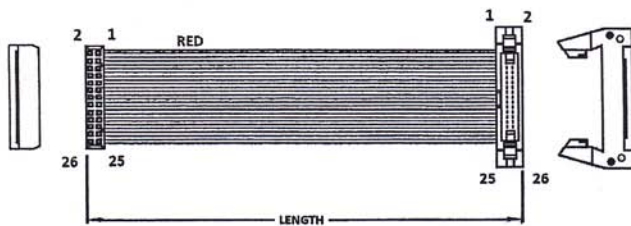

**K2MW**

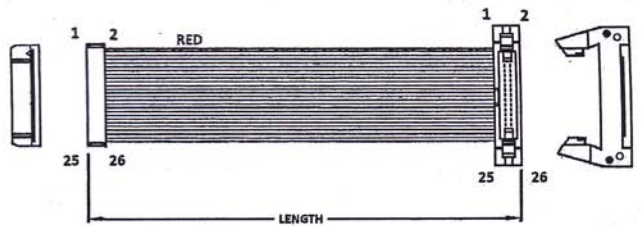

**K2MX**

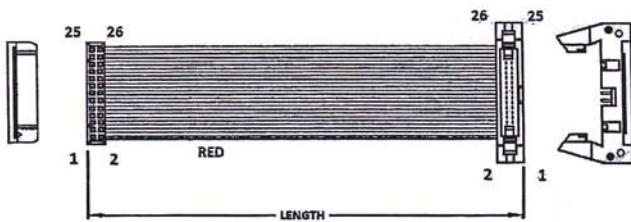

**K2MY**

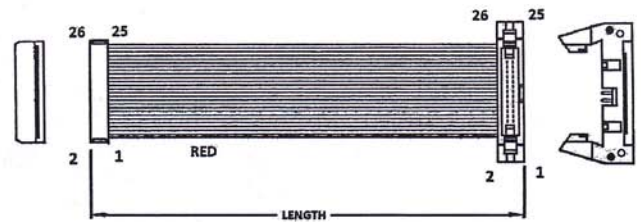

**K2MZ**

**ORDERING INFORMATION:**

**P/N K 1 2 3 4**

1. CONSTRUCTION TYPE:  
2MW, 2MX, 2MY, 2MZ
2. NO. OF CONTACTS:  
010~050
3. LENGTH IN CM (CENTIMETERS)
4. COLOR OF TWO IDC CONNECTORS:  
"D" BLACK(SOCKET)+GRAY(HEADER)

**1.00MM PITCH FLAT CABLE WITH 2.00MM IDC SOCKET W/O S.R. (H=8.5MM)  
TO IDC PLUG WITH SHORT LATCHES (M3)**

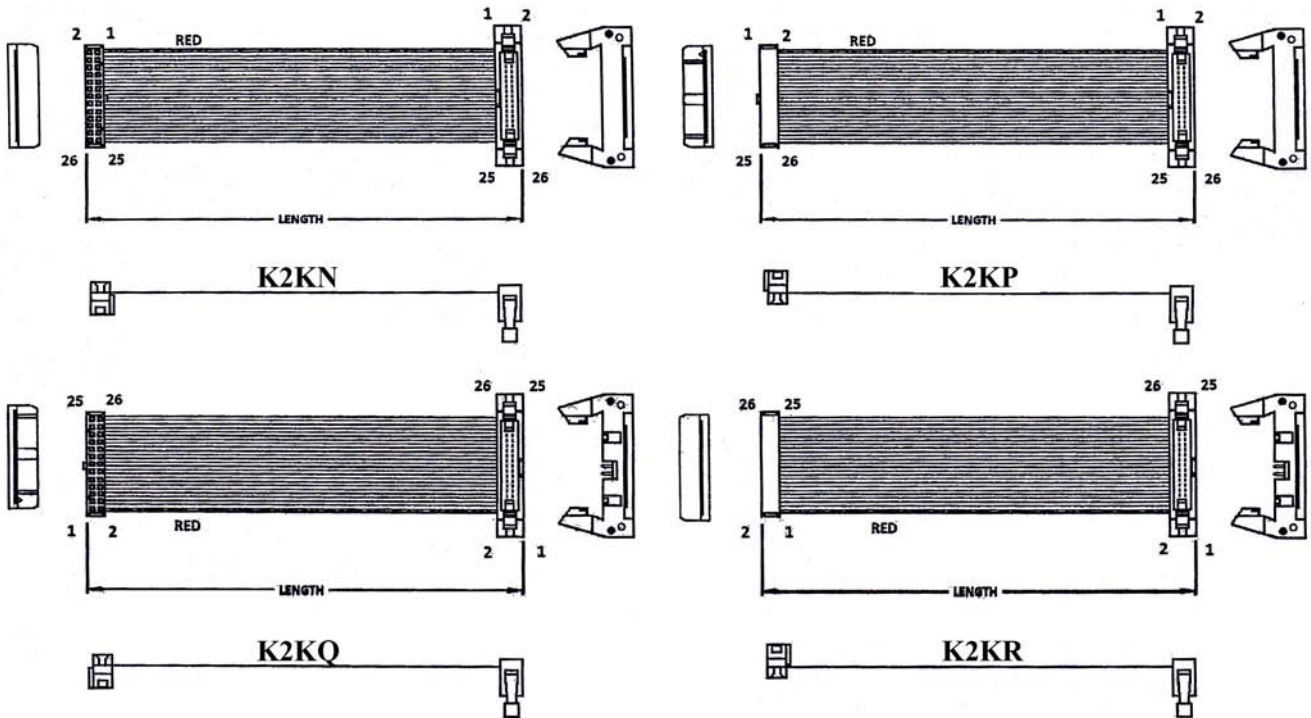

**ORDERING INFORMATION:**

**P/N K 1 2 3 4**

1. CONSTRUCTION TYPE:  
2KN, 2KP, 2KQ, 2KR
2. NO. OF CONTACTS:  
010~068
3. LENGTH IN CM (CENTIMETERS)
4. COLOR OF TWO IDC CONNECTORS:  
"D" BLACK(SOCKET)+GRAY(HEADER)

**1.00MM PITCH FLAT CABLE WITH 2.00MM IDC SOCKET WITH S.R. (H=7.8MM)  
TO IDC PLUG WITH SHORT LATCHES (M4)**

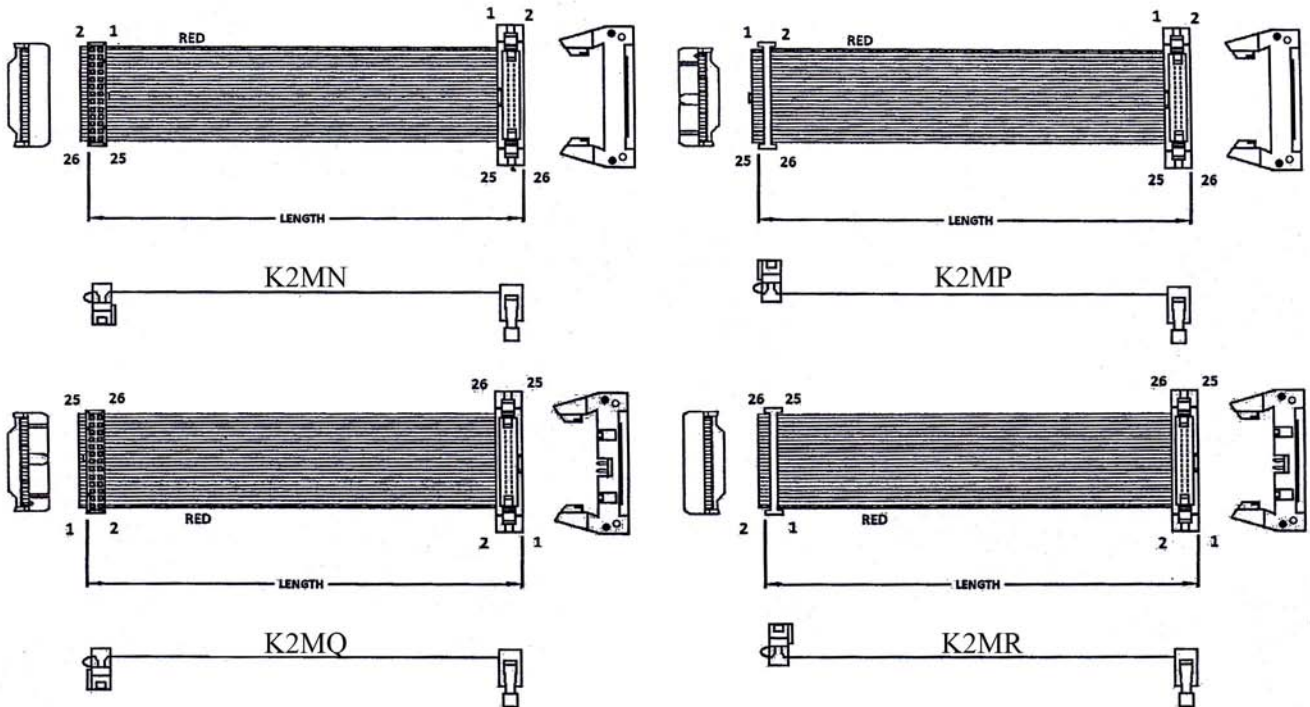

**ORDERING INFORMATION:**

**P/N K 1 2 3 4**

1. CONSTRUCTION TYPE:  
2MN, 2MP, 2MQ, 2MR
2. NO. OF CONTACTS:  
010~050
3. LENGTH IN CM (CENTIMETERS)
4. COLOR OF TWO IDC CONNECTORS:  
"D" BLACK(SOCKET)+GRAY(HEADER)



**1.00MM PITCH FLAT CABLE WITH 2.00MM IDC SOCKET WITH S.R. (H=11.4MM)  
TO IDC PLUG WITH SHORT LATCHES (M5)**

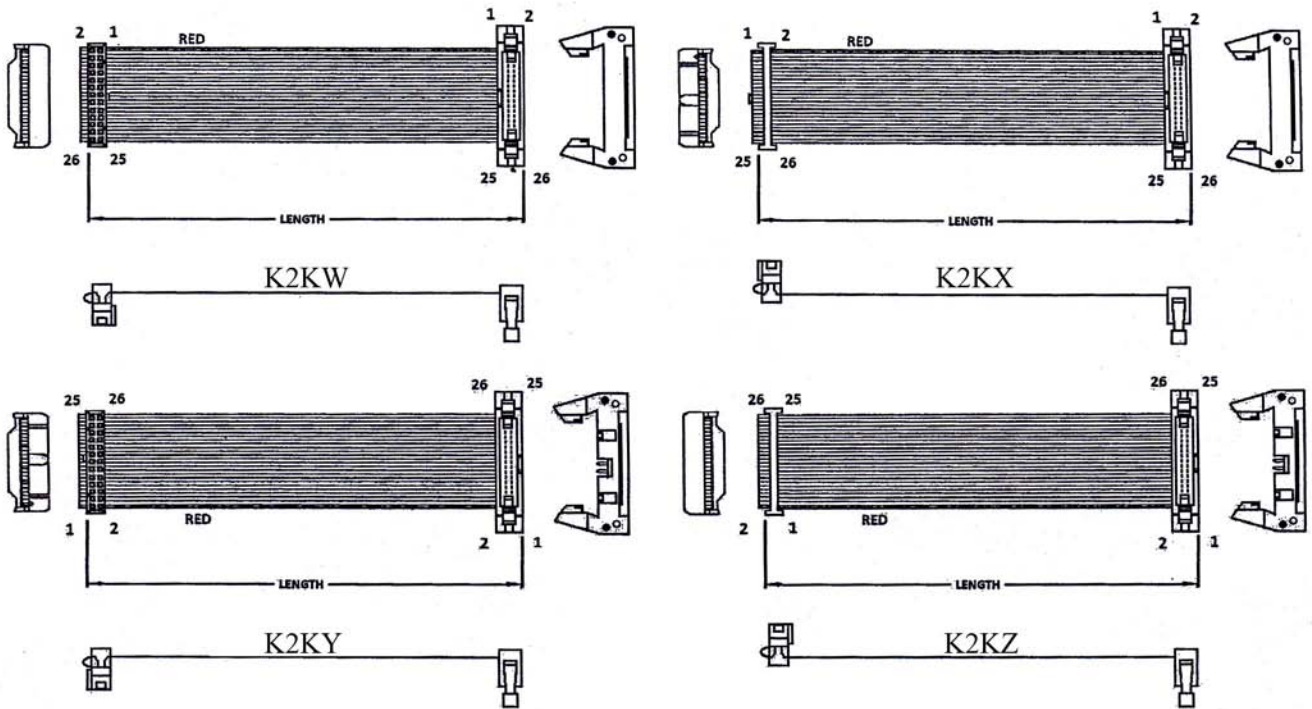

**ORDERING INFORMATION:**

**P/N**  $K \frac{x}{1} \frac{x}{2} \frac{x}{3} \frac{x}{4} - \frac{x}{3} \frac{x}{4} C M D$

1. CONSTRUCTION TYPE:  
2KW, 2KX, 2KY, 2KZ
2. NO. OF CONTACTS:  
010~068
3. LENGTH IN CM (CENTIMETERS)
4. COLOR OF TWO IDC CONNECTORS:  
"D" BLACK(SOCKET)+GRAY(HEADER)

**1.00MM PITCH FLAT CABLE WITH 2.00MM IDC SOCKET W/O S.R. (H=5.1MM)  
TO IDC PLUG WITH LONG LATCHES (N1)**

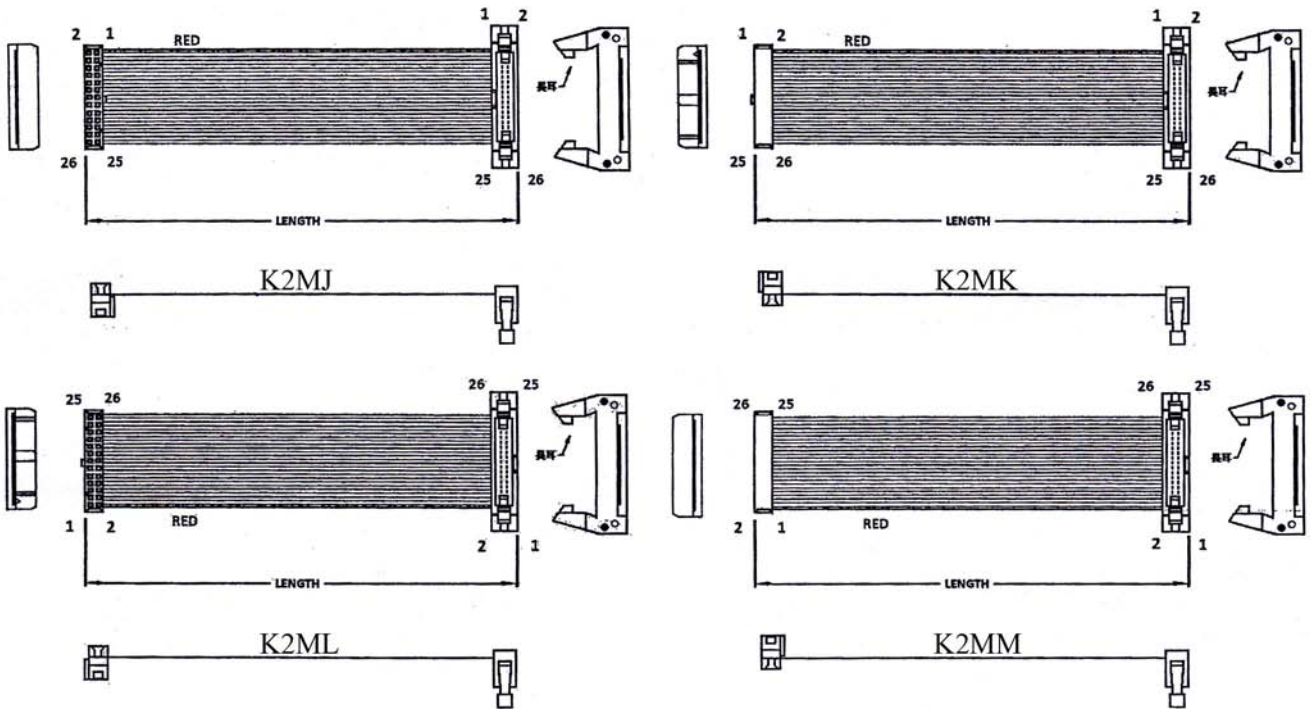

**ORDERING INFORMATION:**

**P/N K 1 2 3 4**

1. CONSTRUCTION TYPE:  
2MJ, 2MK, 2ML, 2MM
2. NO. OF CONTACTS:  
010~050
3. LENGTH IN CM (CENTIMETERS)
4. COLOR OF TWO IDC CONNECTORS:  
"D" BLACK(SOCKET)+GRAY(HEADER)

**1.00MM PITCH FLAT CABLE WITH 2.00MM IDC SOCKET W/O NOSE (H=7.4MM)  
TO IDC PLUG WITH LONG LATCHES (N2)**

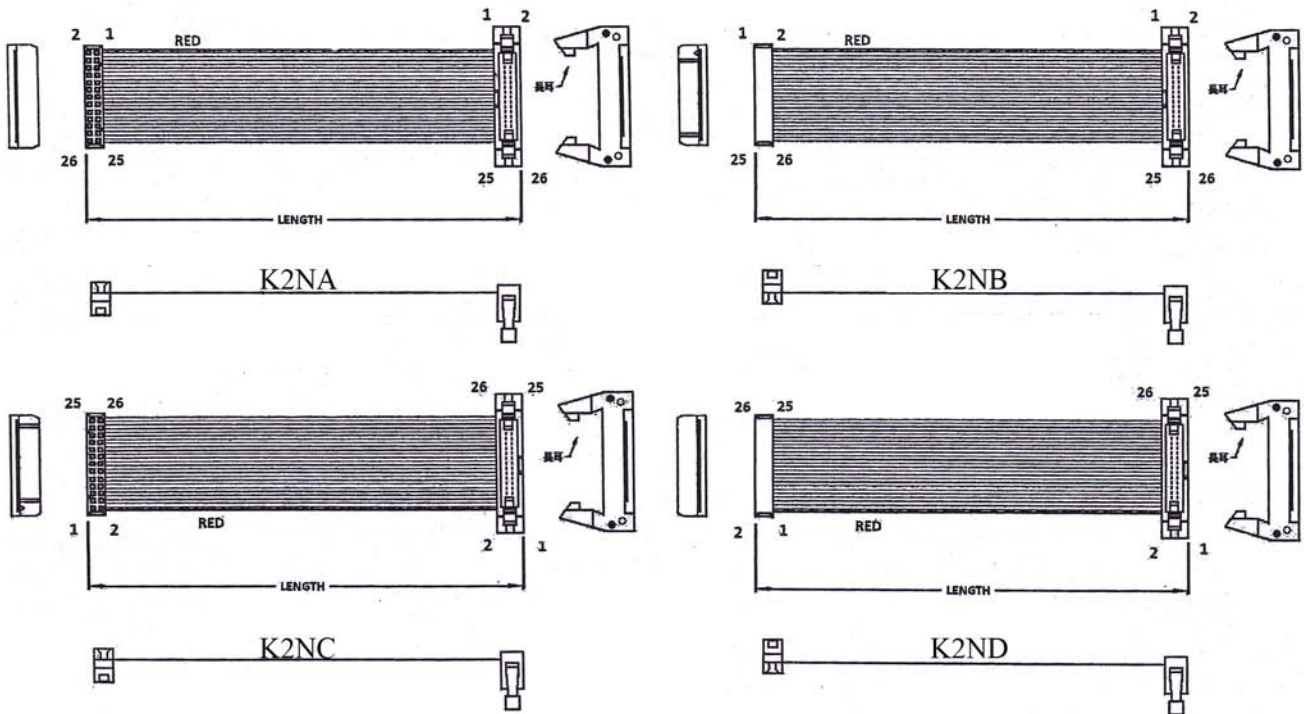

**ORDERING INFORMATION:**

**P/N K 1 2 3 4**

1. CONSTRUCTION TYPE:  
2NA, 2NB, 2NC, 2ND
2. NO. OF CONTACTS:  
010~050
3. LENGTH IN CM (CENTIMETERS)
4. COLOR OF TWO IDC CONNECTORS:  
"D" BLACK(SOCKET)+GRAY(HEADER)

**1.00MM PITCH FLAT CABLE WITH 2.00MM IDC SOCKET WITH S.R. (H=7.8MM)  
TO IDC PLUG WITH LONG LATCHES (N3)**

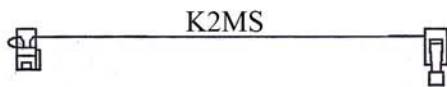
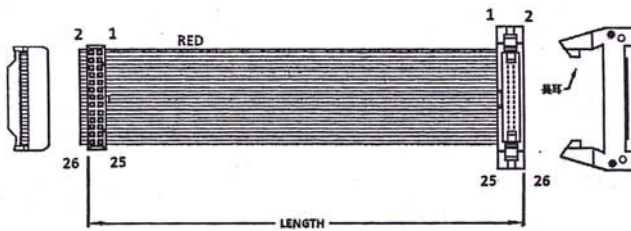

K2MS

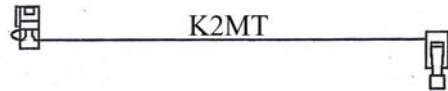
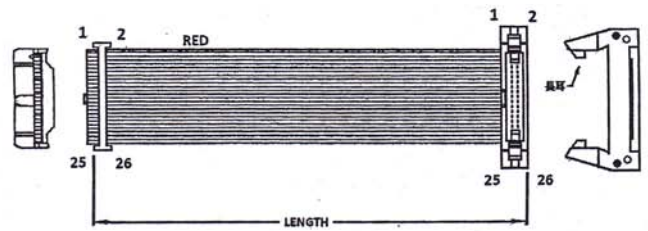

K2MT

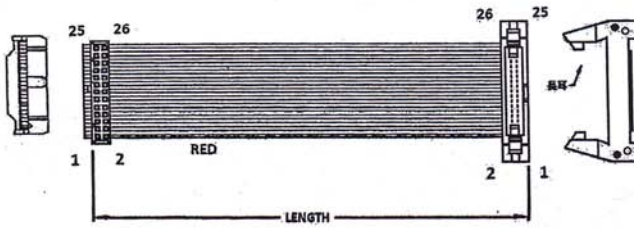

K2MU

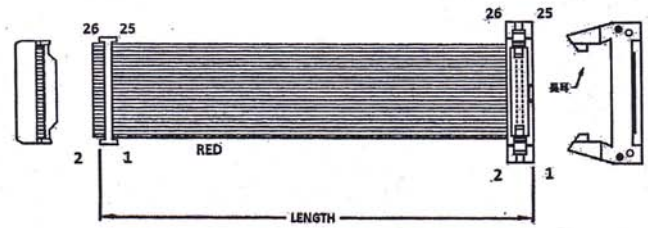

K2MV

**ORDERING INFORMATION:**

**P/N K 1 2 3 4**

1. CONSTRUCTION TYPE:  
2MS, 2MT, 2MU, 2MV
2. NO. OF CONTACTS:  
010~050
3. LENGTH IN CM (CENTIMETERS)
4. COLOR OF TWO IDC CONNECTORS:  
"D" BLACK(SOCKET)+GRAY(HEADER)

**1.00MM PITCH FLAT CABLE WITH 2.00MM IDC SOCKET W/O S.R. (H=8.5MM)  
TO IDC PLUG WITH LONG LATCHES (N4)**

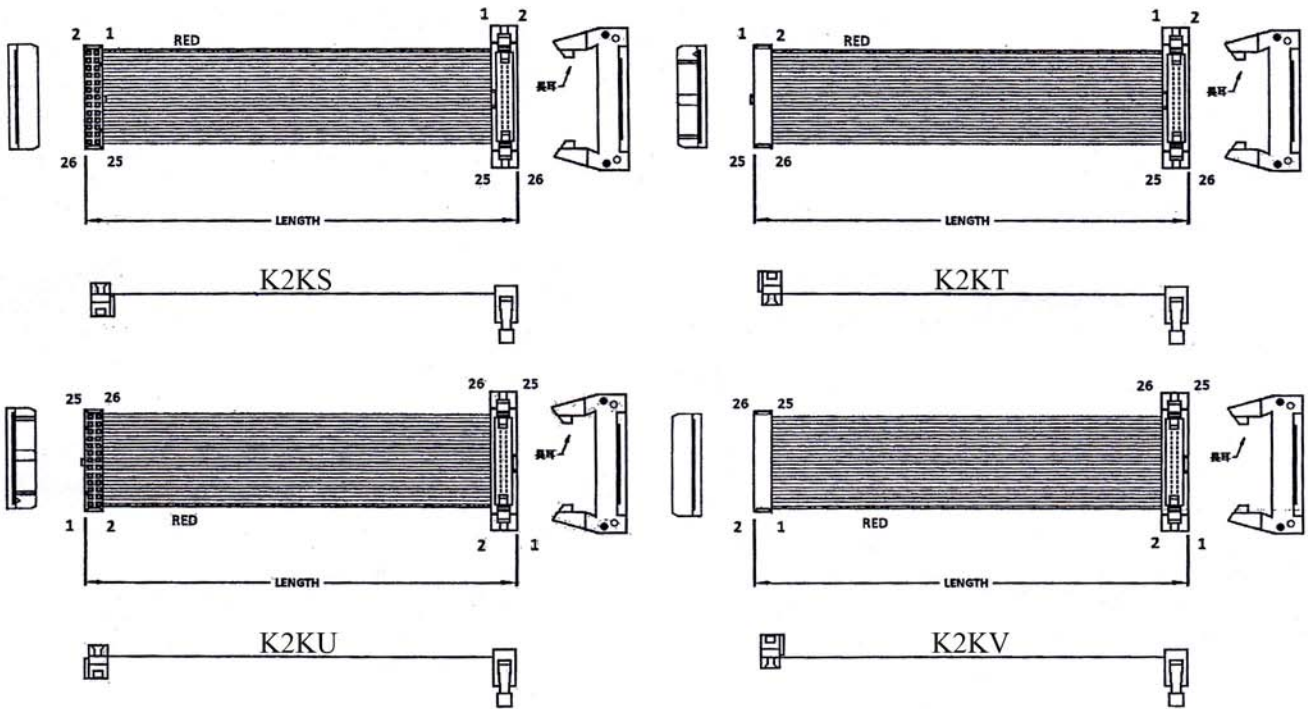

**ORDERING INFORMATION:**

**P/N K 1 2 3 4**

1. CONSTRUCTION TYPE:  
2KS, 2KT, 2KU, 2KV
2. NO. OF CONTACTS:  
010~068
3. LENGTH IN CM (CENTIMETERS)
4. COLOR OF TWO IDC CONNECTORS:  
"D" BLACK(SOCKET)+GRAY(HEADER)

**1.00MM PITCH FLAT CABLE WITH 2.00MM IDC SOCKET WITH S.R. (H=11.4MM)  
TO IDC PLUG WITH LONG LATCHES (N5)**

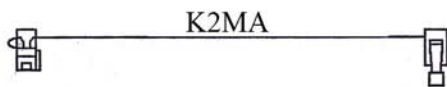
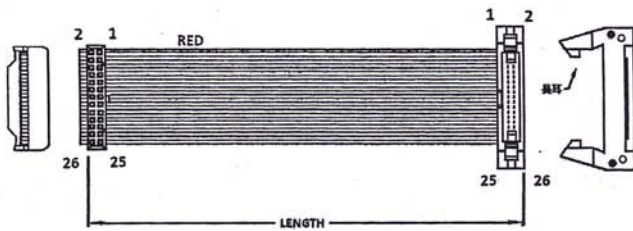

K2MA

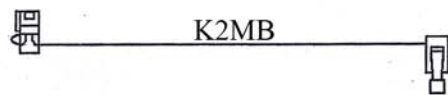
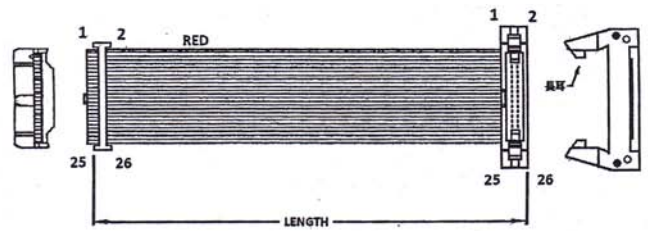

K2MB

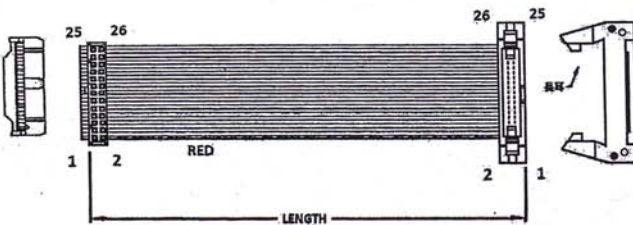

K2MC

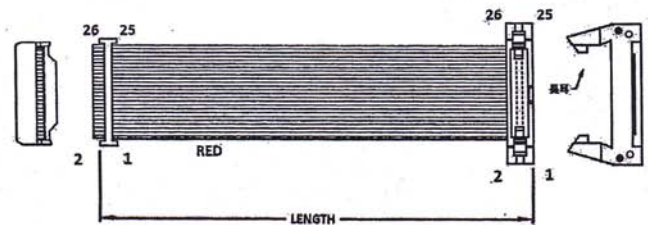

K2MD

**ORDERING INFORMATION:**

**P/N K 1 2 3 4**

1. CONSTRUCTION TYPE:  
2MA, 2MB, 2MC, 2MD
2. NO. OF CONTACTS:  
010~068
3. LENGTH IN CM (CENTIMETERS)
4. COLOR OF TWO IDC CONNECTORS:  
"D" BLACK(SOCKET)+GRAY(HEADER)