

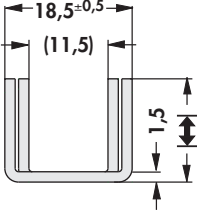

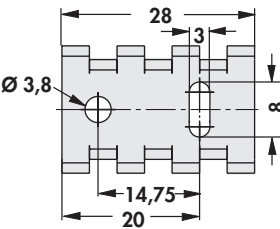

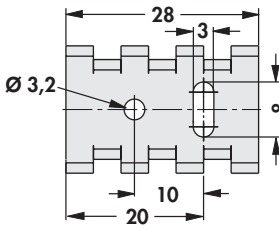

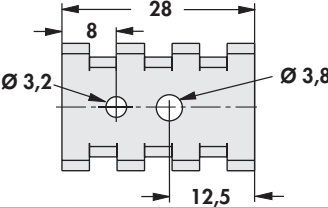

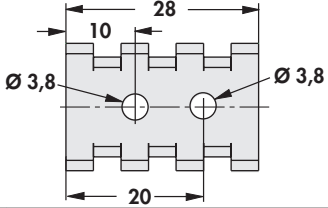

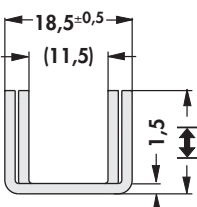
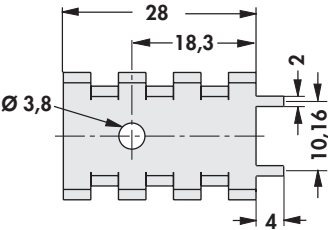
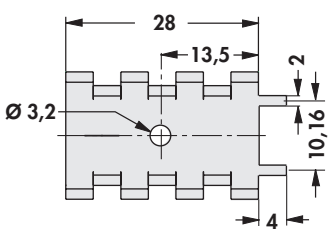

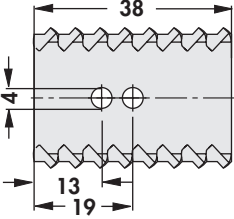
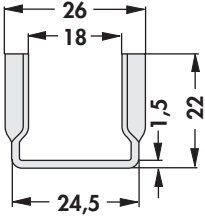

Heatsinks for transistors in plastic case

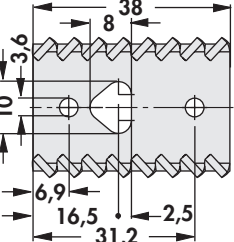
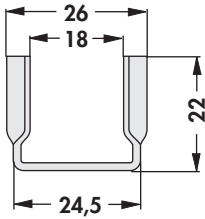

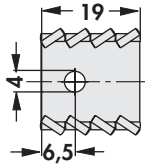
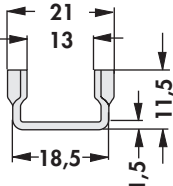

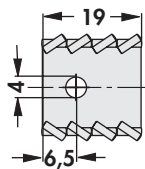
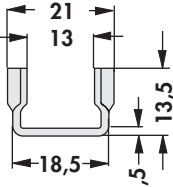

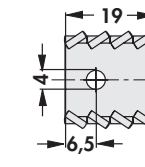
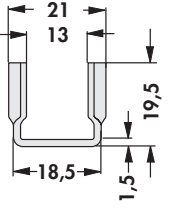

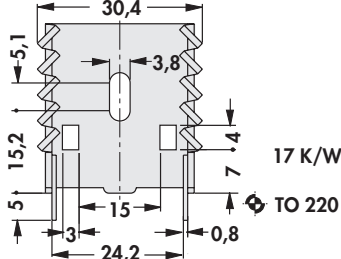
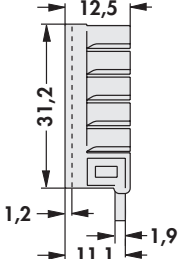

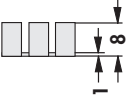
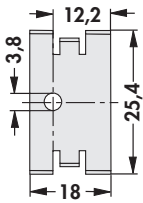
– for semiconductor screw-assembly, horizontal

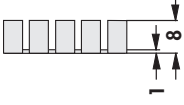
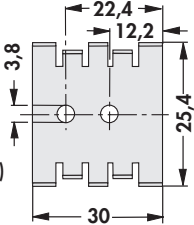
				
				
	art. no.	\pm [mm]	R_{th} [K/W]	Φ
	FK 234 SA L 1	15	17	TO 220
	FK 234 SA L 2			SOT 32
FK 234 SA L 3	CB			
FK 234 SA L 4				
material:	aluminium			
surface:	black anodised			

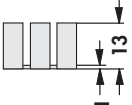
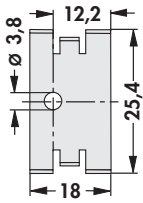
– for semiconductor screw-assembly, vertical

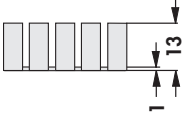
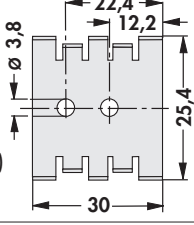
				
	art. no.	\pm [mm]	R_{th} [K/W]	Φ
	FK 235 ... L 1	15	16	TO 220
FK 235 ... L 2	SOT 32			
please indicate:	... surface SA = black anodised MI = solderable surface			
material:	aluminium			

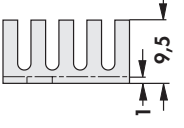
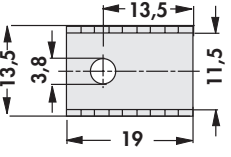
art. no. FK 225 SA L 1			9,9 K/W TO 220	
art. no. FK 225 SA L 2			9,9 K/W TO 220	
art. no. FK 228 SA L 1			30 K/W TO 220	
art. no. FK 229 SA L 1			27 K/W TO 220	
art. no. FK 230 SA L 1			21 K/W TO 220	
material:		aluminium		
surface:		black anodised		
art. no. FK 249 SA 220				
material:		aluminium		
surface:		black passivated, solder pins tin plated		

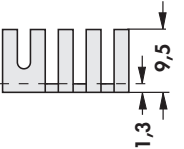
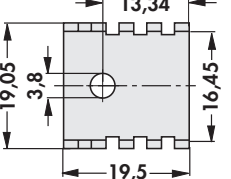
<p>art. no.</p> <p>FK 209 SA 32</p>		 <p>25 K/W SOT 32</p>	
<p>available without hole pattern as well</p>			
<p>art. no.</p> <p>FK 210 SA CB</p>		 <p>18 K/W CB (SOT 32 + TO 220)</p>	
<p>available without hole pattern as well</p>			
<p>art. no.</p> <p>FK 213 SA 32</p>		 <p>21 K/W SOT 32</p>	
<p>available without hole pattern as well</p>			
<p>art. no.</p> <p>FK 214 SA CB</p>		 <p>15 K/W CB (SOT 32 + TO 220)</p>	
<p>available without hole pattern as well</p>			
<p>art. no.</p> <p>FK 231 SA 220</p>		 <p>24 K/W TO 220</p>	
<p>art. no.</p> <p>FK 239 SA 32</p>		 <p>24 K/W SOT 32</p>	
<p>material:</p>		<p>aluminium</p>	
<p>surface:</p>		<p>black anodised</p>	