

SPECIFICATIONS:

RATING: AC125V 7A, AC250V 4A.
 CIRCUIT: DPDT.
 CONTACT RESISTANCE: 20m-ohms max. @ 5VDC 1A.
 DIELECTRIC STRENGTH: AC 1,500V for 1 min.
 LIFE EXPECTANCY: 6-10 cycle / min.
 ELECTRICAL LIFE: 6,000 cycle.
 OPERATING FORCE: 550 ± 150gf.
 OPERATING MODE: Latching and momentary.
 TRAVEL: (Full) 4.8mm. (Lock) 3.3mm.

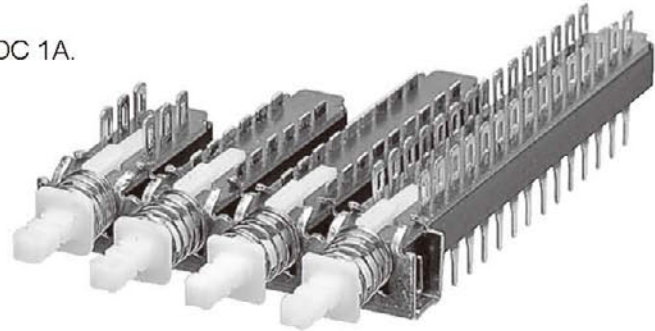

Specifications and Dimensions subject to change

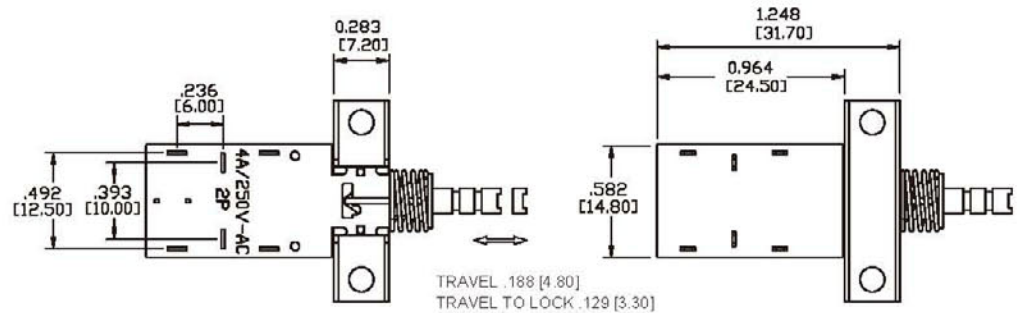
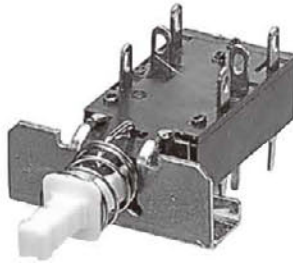

Model No.	Type
WP-1	Momentary
WP-2	Latching

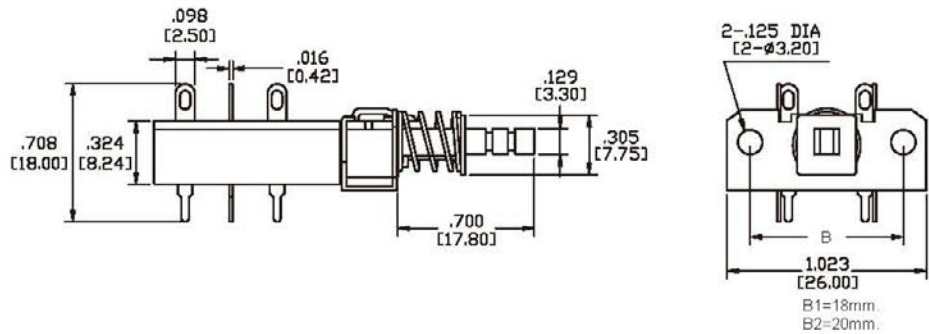

HOW TO ORDER

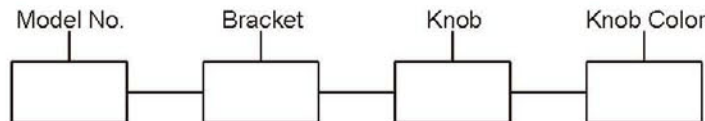

B0=No Bracket
 B1=18mm
 B2=20mm

APPLICATIONS:

WP Series pushbutton switches are suitable to be used in wide variety of applications, such as telecommunications, professional audio, sound and electronic test equipment.

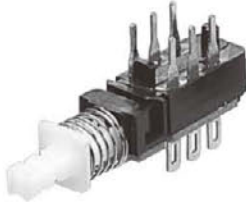

FEATURES:

- Wiping for smooth, silent actuation stroke
- Up to 16 poles per module
- Mounting chassis
- Interlocked assemblies
- Optional terminal length
- Snap-on buttons
- Solder lugs on top for hand wiring
- Switch plunger with soldering contacts is removable from the front without disturbing electrical connections
- Enclosed housing protects inner contact area from dust and external intrusion
- Fixed terminals are "staked" in position providing an extra protection to help preventing weakening of solder or flux

SPECIFICATIONS:

CONTACT RESISTANCE: Initial 5m-ohms max., after 25,000 cycles 20m-ohms max.
 CURRENT AND VOLTAGE: 0.5A @ 100VAC, 0.2A @ 250VAC, 1A @ 25VDC.
 DIELECTRIC STRENGTH: 1,500VAC for 1 min.
 INSULATION RESISTANCE: Adjacent Contacts- 2×10^{12} ohms min. (Dry Condition), 3×10^{11} ohms min. (100% Relative Humidity after 96 hrs @70°F); Life Test-100,000 cycles min.
 LIFE CYCLE: $\geq 1 \times 10^5$

MATERIALS:

HOUSING: Polycarbonate (UL94HB).
 PLUNGER: Duracon (UL94HB).
 TERMINAL BOARD: Polycarbonate.
 MOVING CONTACTS: Brass base silver plated.
 FIXED CONTACTS: Brass with silver plate over nickel plate.
 MOVABLE CONTACT RETURN SPRING: Stainless steel spring.
 PLUNGER RETURN SPRING: Baked & Zinc plated steel spring.
 ALTERNATE ACTION STAPLE: Highly resistant steel-wire, Chrome plated.
 TERMINAL DIE BOND: High strength bonding red resin.
 RELEASE BAR: Steel/Zinc plated.
 CHASSIS: Steel/Nickel plated or steel/zinc plated.
 RELEASE BAR SPRING: Stainless steel.
 CONTACTS: (Q) Silver plating, (R) Gold plating.

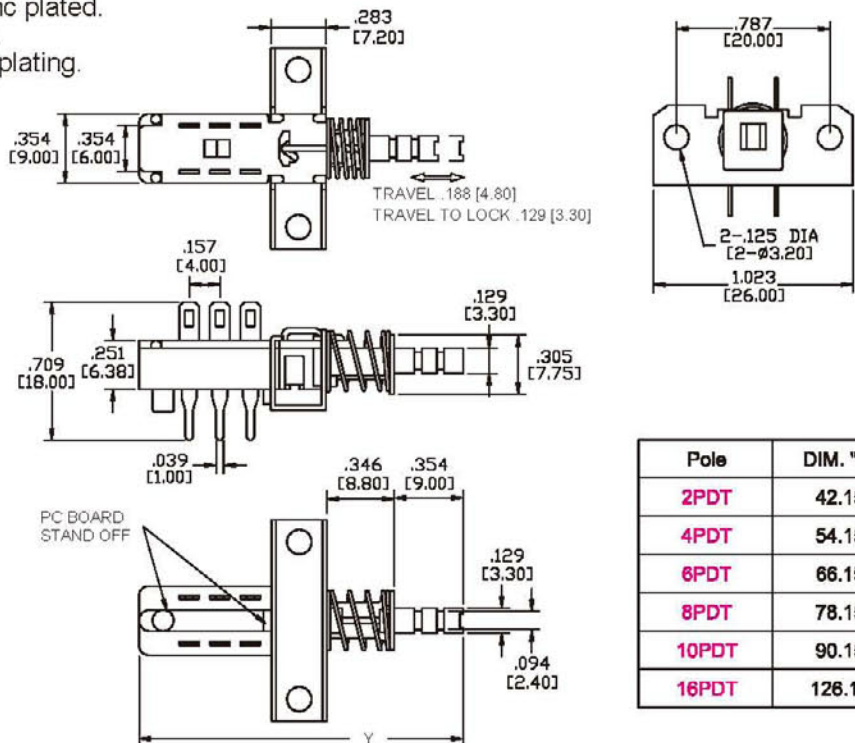
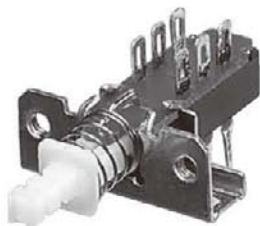

Model No.	Type
WP-3	Momentary
WP-4	Latching
WP-5	Interlocking

POLE & PITCH & TERMINATION OPTIONS

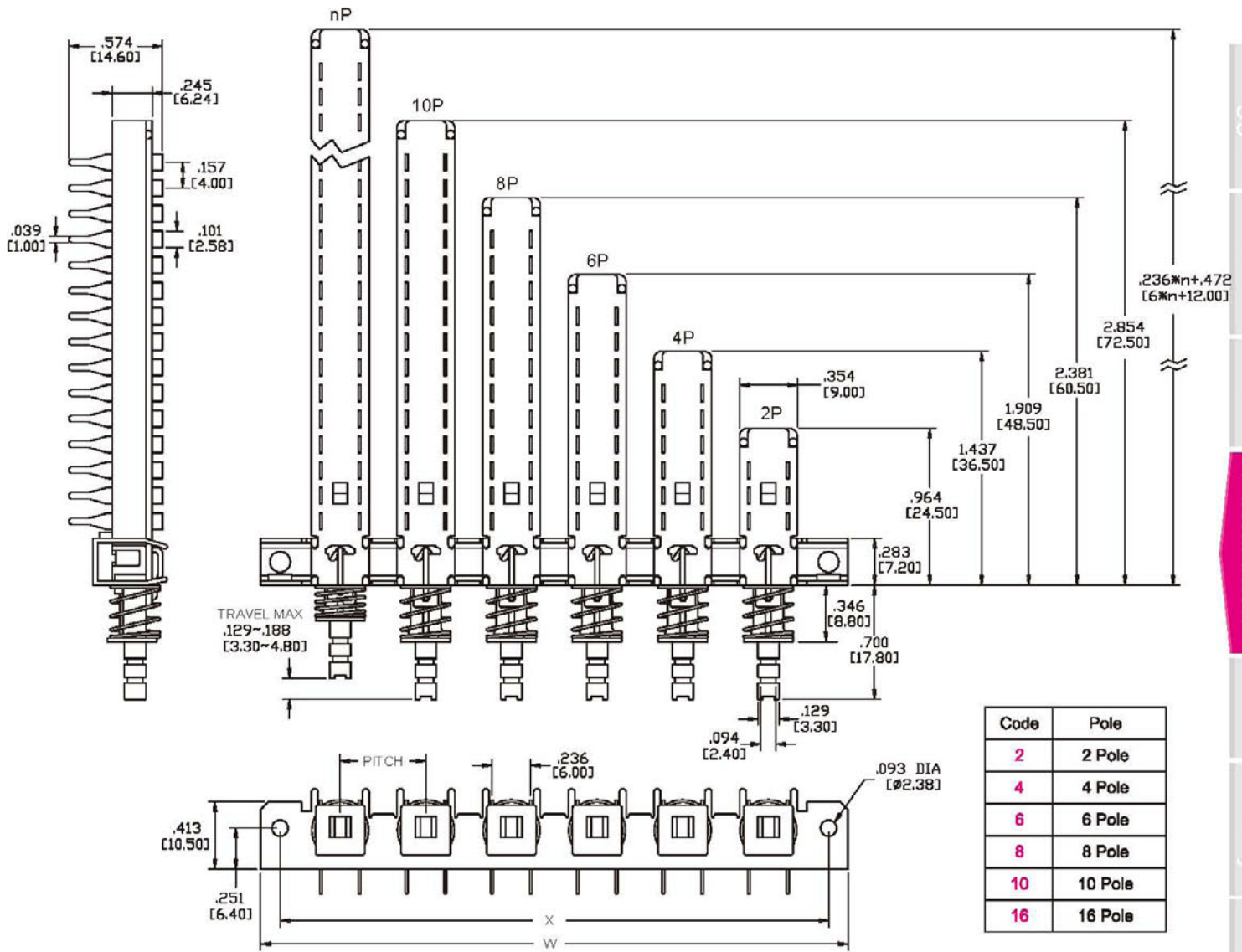

CODE OF SWITCH NUMBER	A	B	C	D	E	F	G	H	J	K	L	M	N	P	Q	R	S	T	U
CODE OF PITCH (mm)	Switch Number																		
1(10.0)	W 36.0	46.0	56.0	66.0	76.0	86.0	96.0	106.0	116.0	126.0	136.0	146.0	156.0	166.0	176.0	186.0	196.0	206.0	216.0
	X 30.0	40.0	50.0	60.0	70.0	80.0	90.0	100.0	110.0	120.0	130.0	140.0	150.0	160.0	170.0	180.0	190.0	200.0	210.0
2(12.5)	W 38.5	51.0	63.5	76.0	88.5	101.0	113.5	126.0	138.5	151.0	163.5	176.0	188.5	201.0	213.5	226.0	238.5	251.0	263.5
	X 32.5	45.0	57.5	70.0	82.5	95.0	107.5	120.0	132.5	145.0	157.5	170.0	182.5	195.0	207.5	220.0	232.5	245.0	257.5
3(15.0)	W 41.0	56.0	71.0	86.0	101.0	116.0	131.0	146.0	161.0	176.0	191.0	206.0	221.0	236.0	251.0	266.0	281.0	296.0	311.0
	X 35.0	50.0	65.0	80.0	95.5	110.0	125.0	140.0	155.0	170.0	185.0	200.0	215.0	230.0	245.0	260.0	275.0	290.0	305.0
4(17.5)	W 43.8	61.0	78.5	96.0	113.5	131.0	148.5	166.0	183.5	201.0	218.5	236.0	253.0	271.0	288.5	306.0	323.5	341.0	358.5
	X 37.5	55.0	72.5	90.0	107.5	125.0	142.5	160.0	177.5	195.0	212.5	230.0	247.5	265.0	282.5	300.0	317.5	335.0	352.5
5(20.0)	W 46.0	66.0	86.0	106.0	126.0	146.0	166.0	186.0	206.0	226.0	246.0	266.0	286.0	306.0	326.0	346.0	366.0	386.0	406.0
	X 40.0	60.0	80.0	100.0	120.0	140.0	160.0	180.0	200.0	220.0	240.0	260.0	280.0	300.0	320.0	340.0	360.0	380.0	400.0

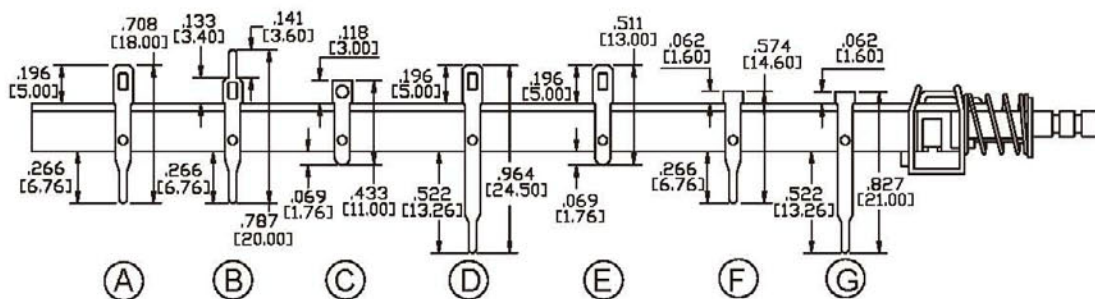

KNOB OPTIONS

PLASTIC CAP

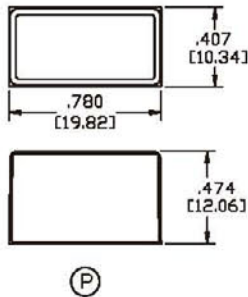
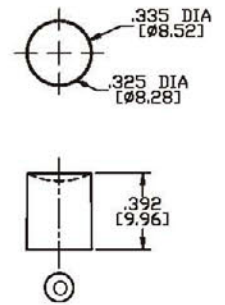
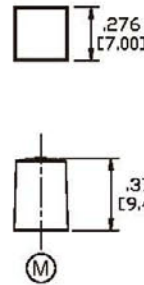
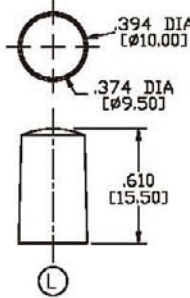
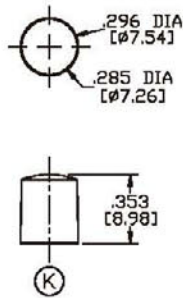
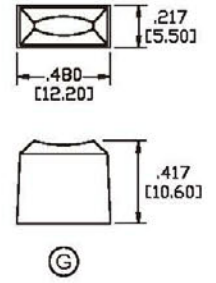
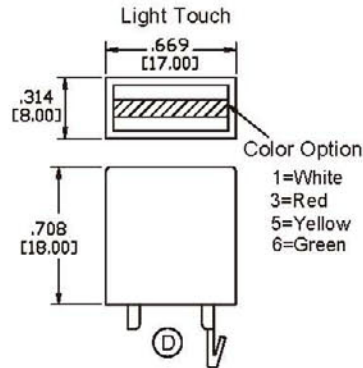
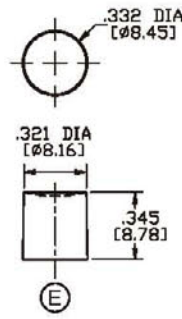
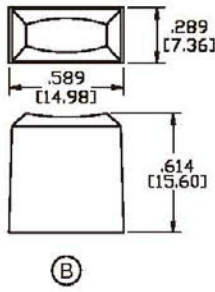

Code	Cap Color
1	White
2	Black
3	Red
4	Chrome
7	Gray

ALUMINUM CAP

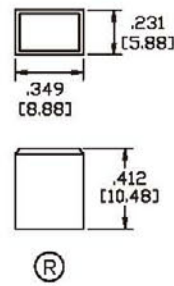
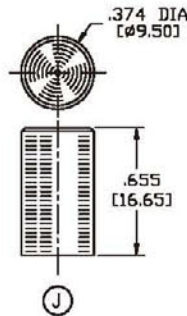
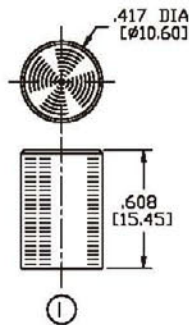
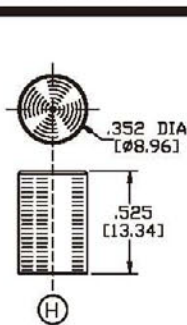

Code	Cap Color
2	Black
4	Chrome
8	Gold

HOW TO ORDER

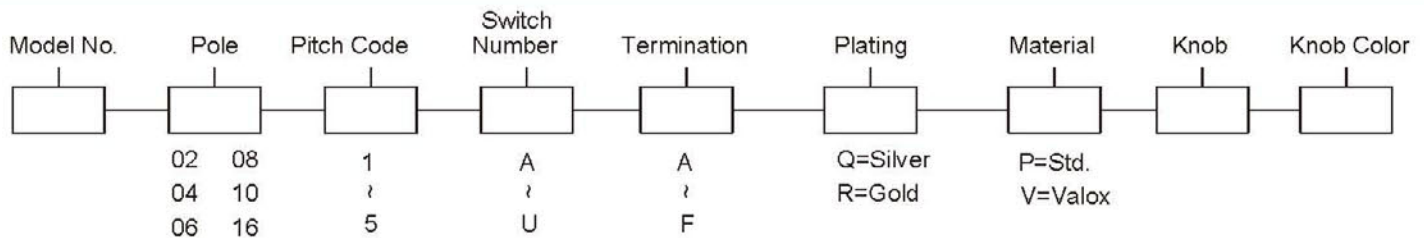

SPECIFICATIONS:

CONTACT RATING: 200mA @30 VAC or VDC max.
 ELECTRICAL LIFE: 30,000 make-and-break cycle at full load.
 CONTACT RESISTANCE: 20m-ohms max. @ 2-4 VDC, 100mA for both silver and gold plated contacts.
 INSULATION RESISTANCE: 100M-ohms min.
 DIELECTRIC STRENGTH: 500VAC for 1 minute.
 OPERATING TEMPERATURE: -10°C to +60°C.

Specifications and Dimensions subject to change

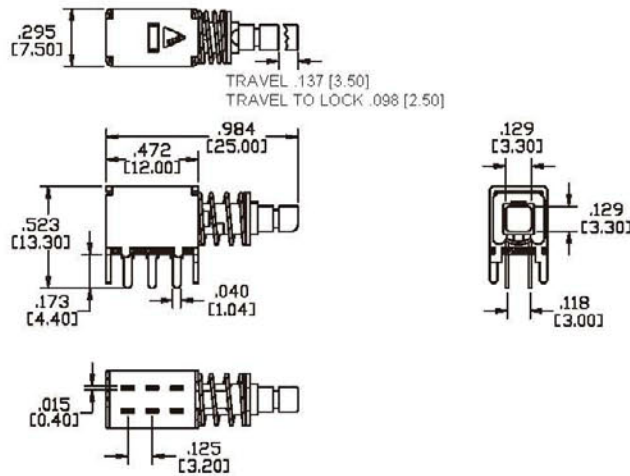
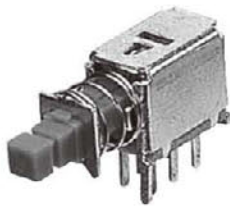

Schematic

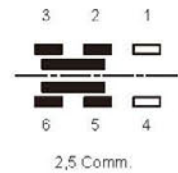

Model No.	Type
WP-6	Momentary
WP-7	Latching

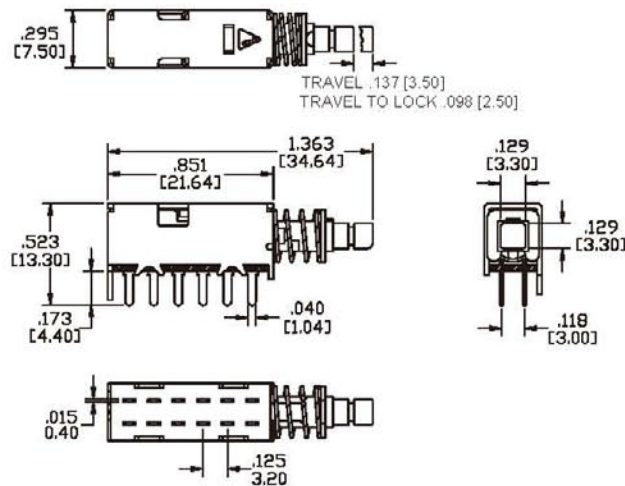
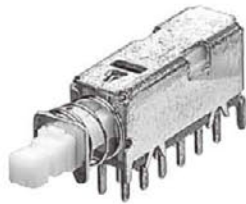

Schematic

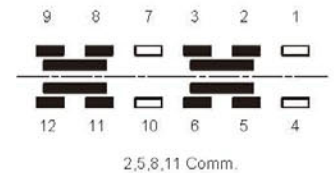

Model No.	Type
WP-8	Momentary
WP-9	Latching

HOW TO ORDER

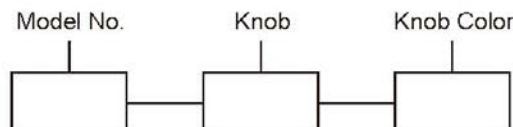

SPECIFICATIONS:

RATING: AC 100V @ 0.5A, AC 250V @ 0.2A, DC 25V @ 1A.
 CONTACT RESISTANCE: 50m-ohms min.
 INSULATION RESISTANCE: 100M-ohms min at 500VDC.
 DIELECTRIC STRENGTH: 1,000VAC for 1minute.
 NO. OF KEY: Any key (2-13keys).
 KEY PITCH: 10mm, 12.5mm, 15mm, 17.55mm, 20mm.
 OPERATING TEMPERATURE: -20°C ~ +70°C.
 LIFE CYCLE: Contact resistance less than 50m-ohms after 20,000 cycles of operation.
 BLOCK COMBINATION: Whichever of self-locking, inter-locking or non-locking.
 TERMINAL: PC. board terminal, wiring terminal.
 TIMING: Non shorting-shorting.
 TYPICAL APPLICATION: Dry circuit switching.

MATERIALS:

CONTACT FINISH: Silver plated.
 TERMINAL: Brass or copper.
 TERMINAL FINISH: Silver plated.

Specifications and Dimensions subject to change

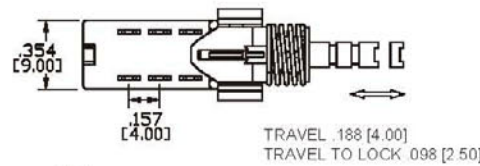
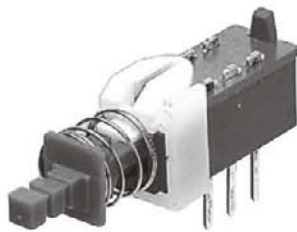

2 POLE

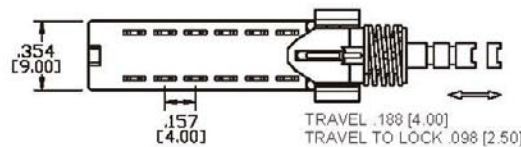
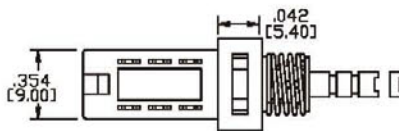
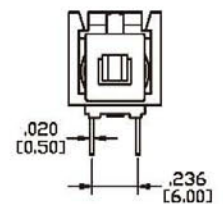
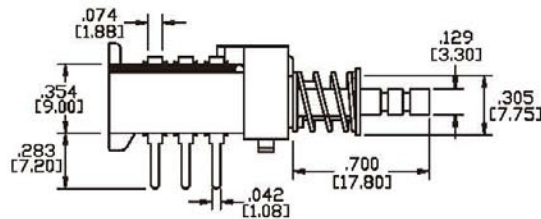

4 POLE

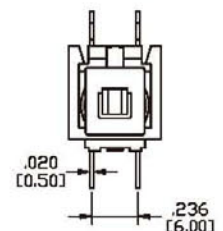
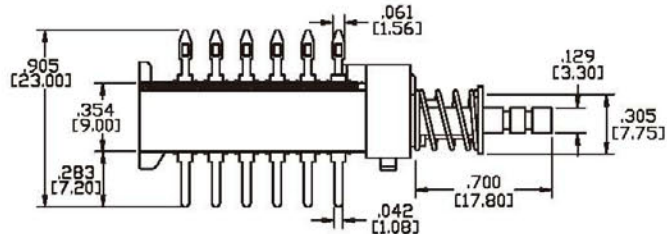

Model No.	Type
WPA-1	Momentary
WPA-2	Latching
WPA-3	Interlocking

POLE & TRAVEL OPTIONS

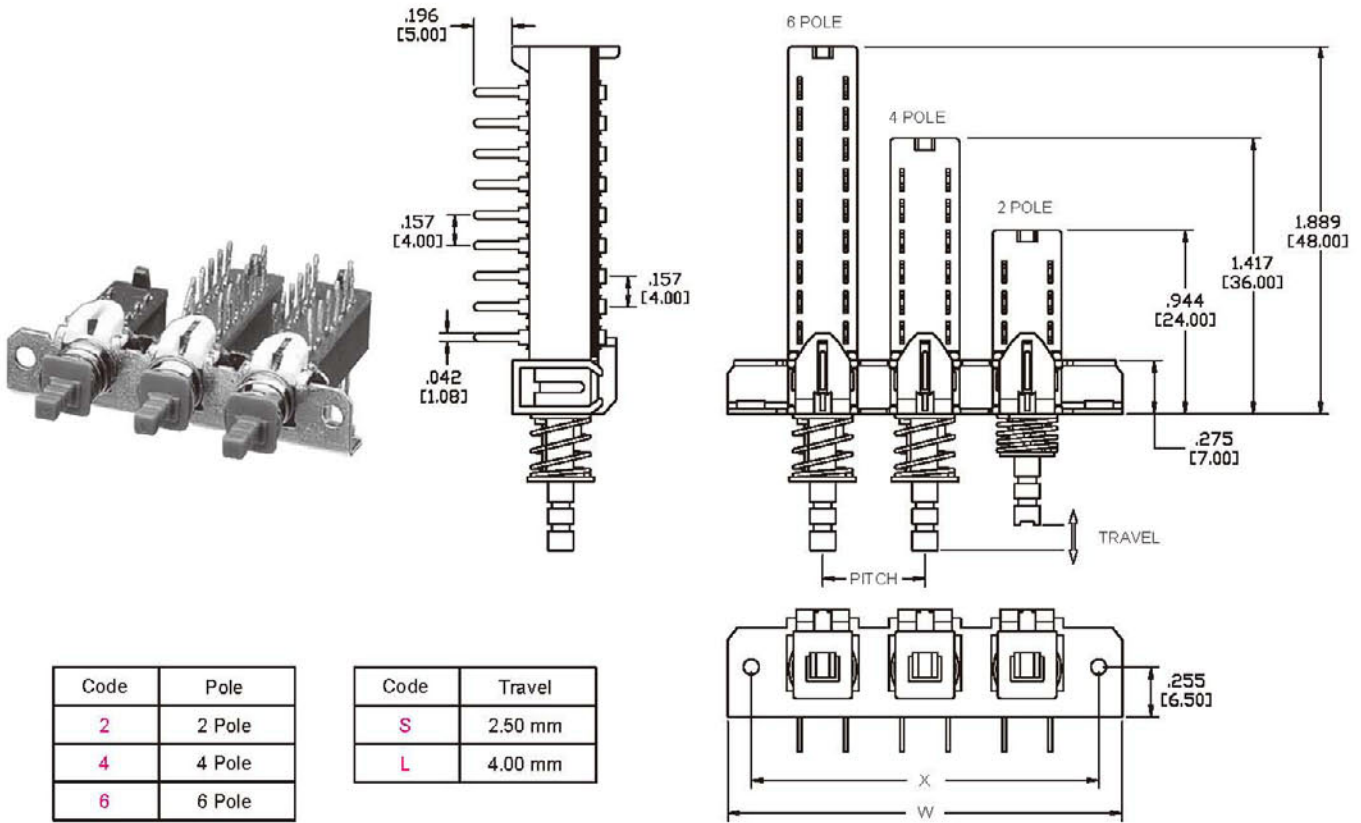

Code	Pole
2	2 Pole
4	4 Pole
6	6 Pole

Code	Travel
S	2.50 mm
L	4.00 mm

For Pitch, X & W please refer to page 165.

TERMINATION OPTIONS

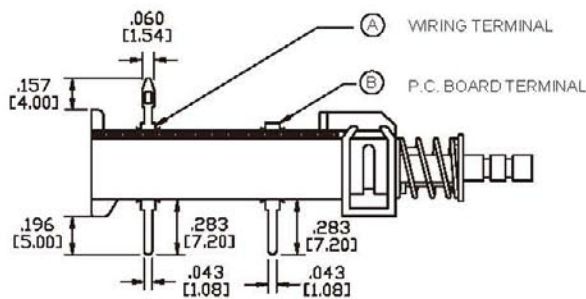

HOW TO ORDER

