

SPECIFICATION:

CONTACT RATING: Refer to "Contact Material Options" for more info.
 ELECTRICAL LIFE: 30,000 make-and-break cycles at full load.
 CONTACT RESISTANCE: 20mΩ max. initial @2-4 VDC
 100mA for both silver and gold plated contacts.
 INSULATION RESISTANCE: 1000MΩ min.
 DIELECTRIC STRENGTH: 1500V RMS @ sea level.
 OPERATING TEMPERATURE: -30°C to +85°C.

MATERIALS:

CASE: Diallyl phthalate(DAP)(UL 94V-0).
 PLUNGER: Polybutylene terephthalate (PBT) or Nylon 6/6.
 BUSHING: Brass, nickel plated.
 SWITCH SUPPORT: Brass, tin plated.
 HOUSING: Stainless steel.
 TERMINAL SEAL: Epoxy.

Specifications and Dimensions subject to change

If your preferred product configuration is not shown, please contact our sales representative for custom design.

HOW TO ORDER SYSTEM

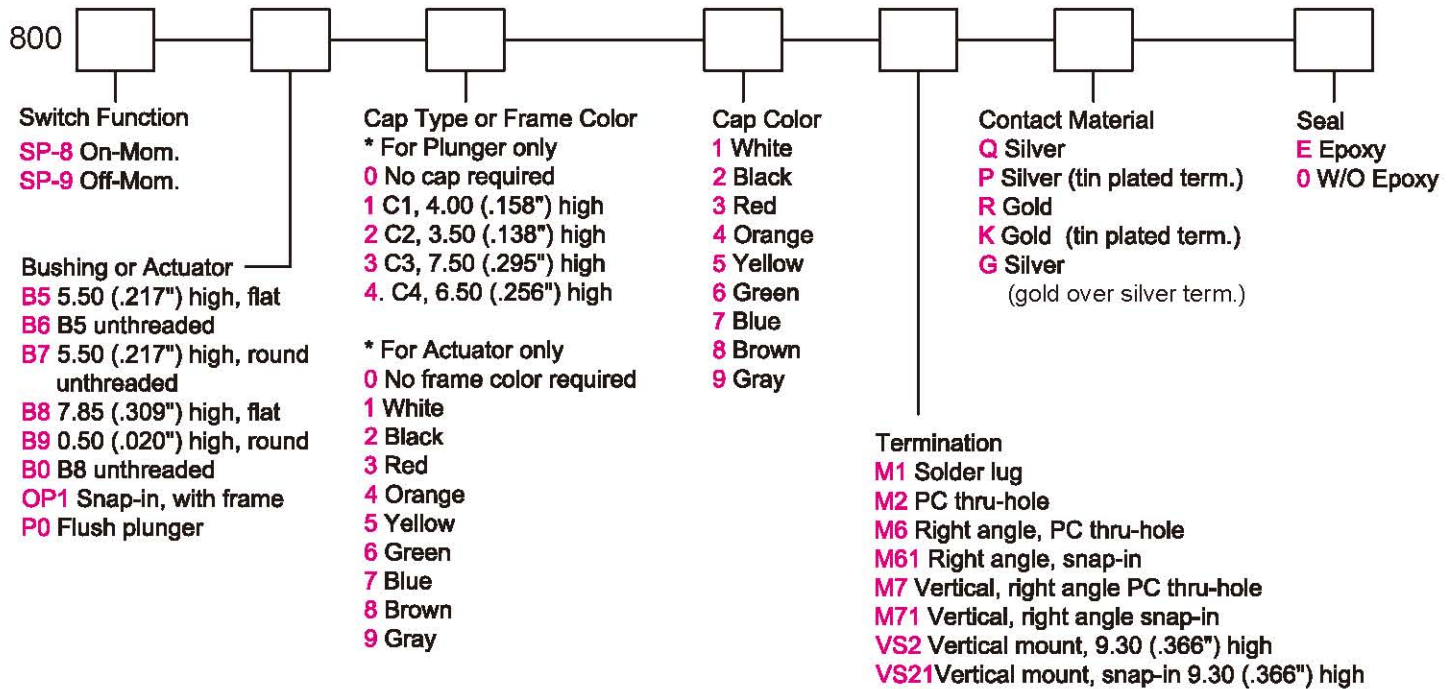

SPST



Model No.	Type	
SP-9	OFF	MOM

Schematic

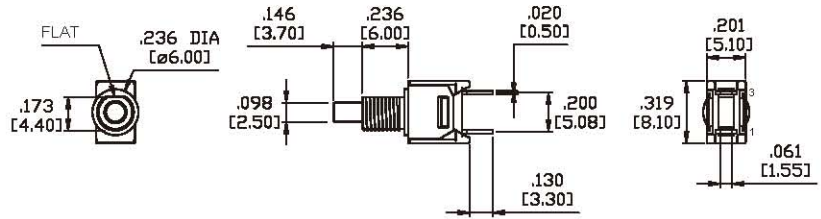

SPDT



Model No.	Type	
SP-8	ON	MOM
Term. Comm.	2-1	2-3

Schematic

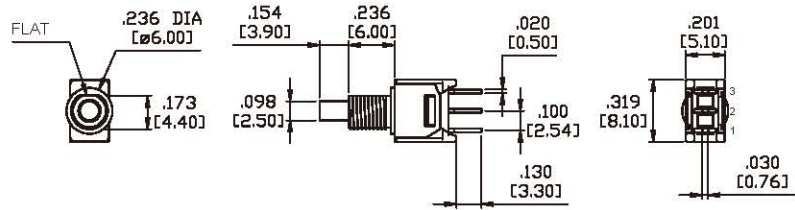
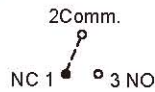

ACTUATOR OPTIONS FOR SNAP-IN FRONT MOUNT

OP1

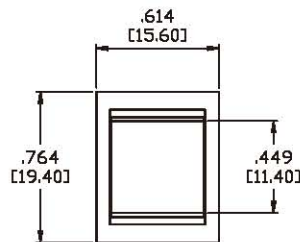
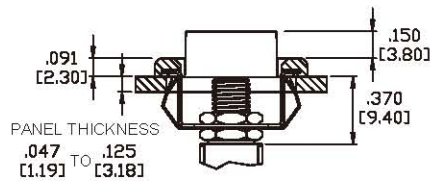

PANEL MOUNTING

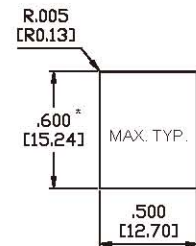

* Increase this dimension to .620/.625 [15.75/15.88] for .091/.125 [2.31/3.18] thk. panels.

OP1 WITHOUT FRAME

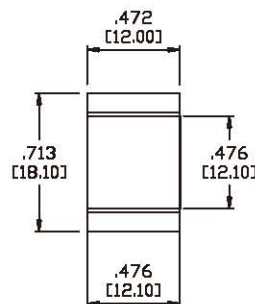
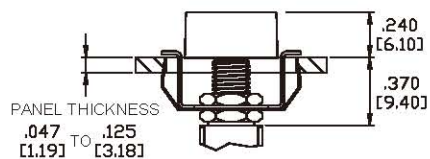

PANEL MOUNTING

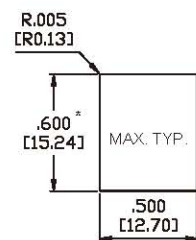

* Increase this dimension to .620/.625 [15.75/15.88] for .091/.125 [2.31/3.18] thk. panels.

BUSHING OPTIONS

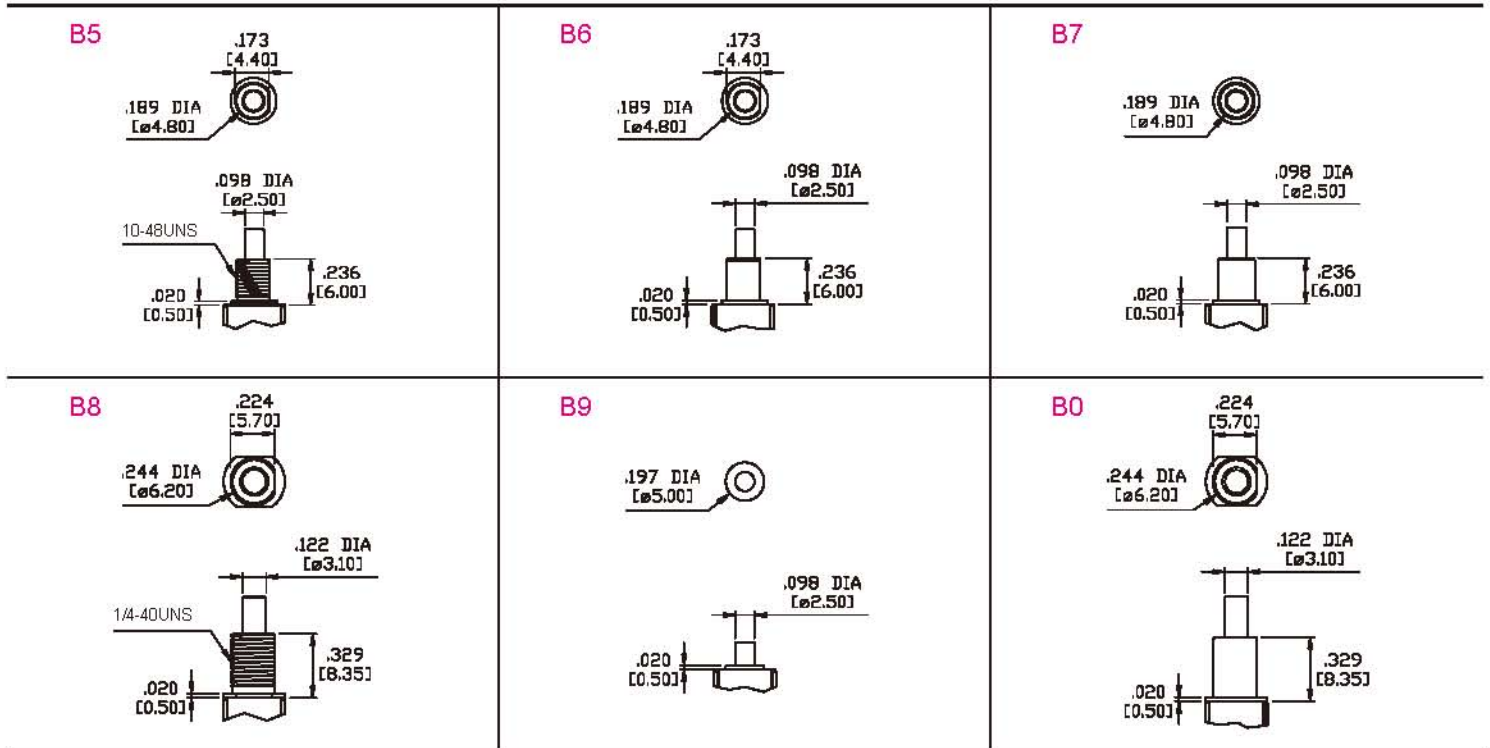

TERMINATION OPTIONS

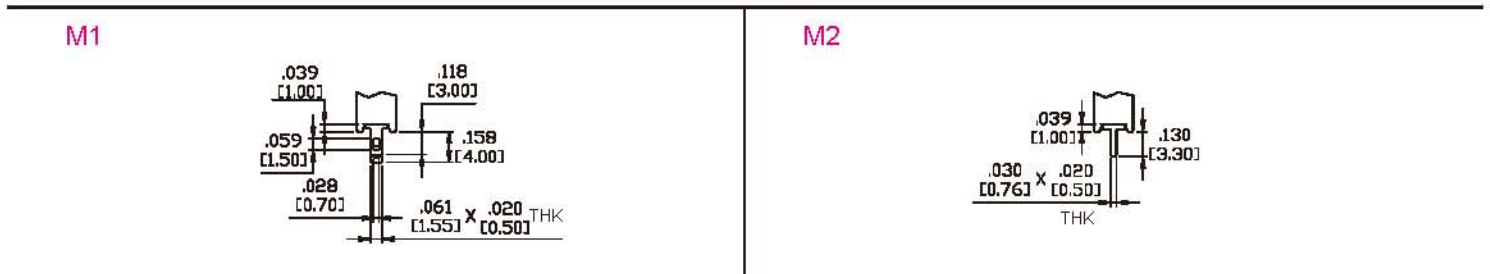

TERMINATION OPTIONS

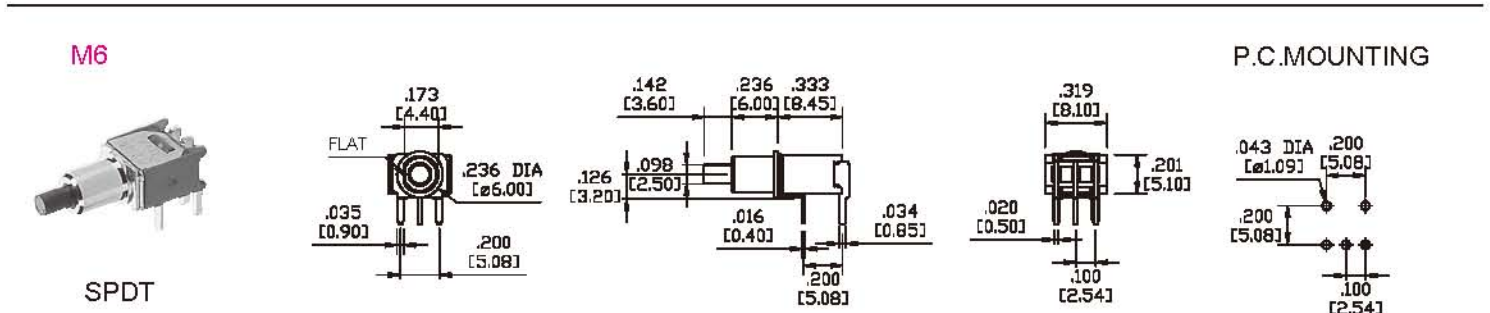
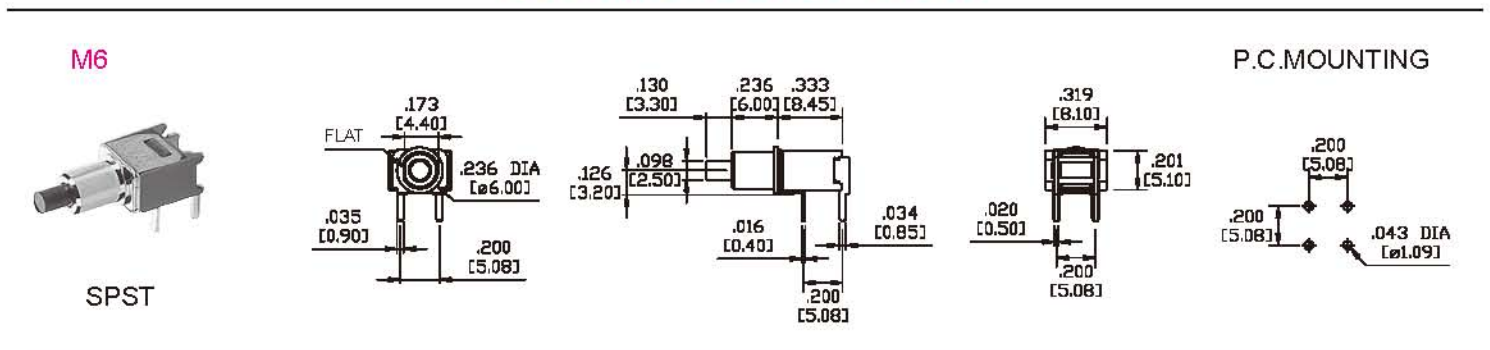

TERMINATION OPTIONS

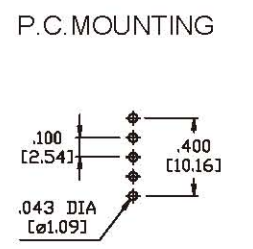
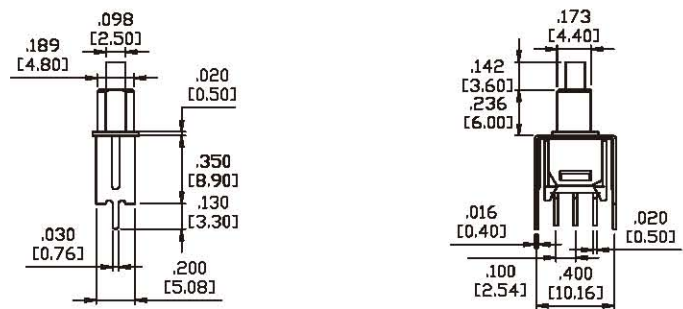
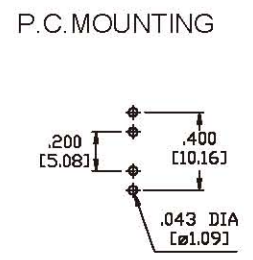
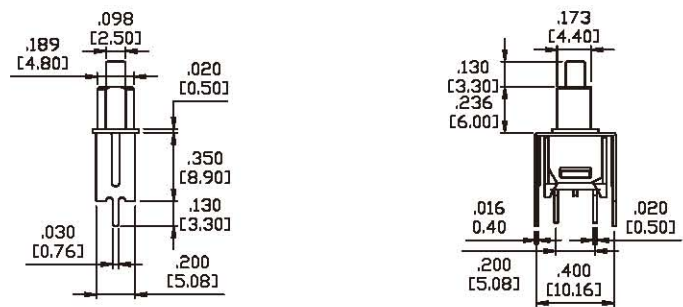
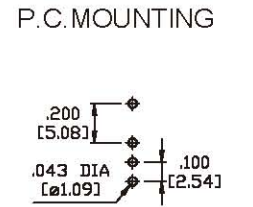
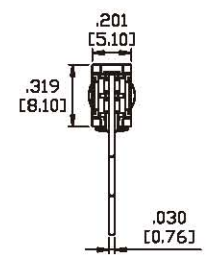
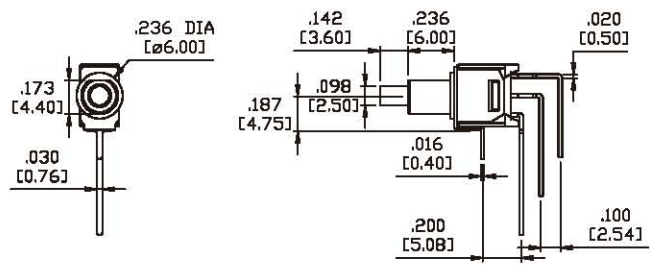
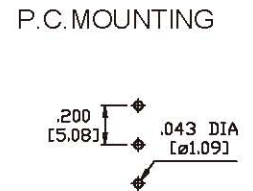
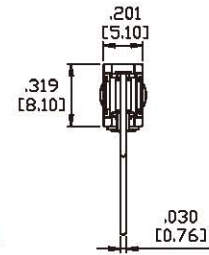
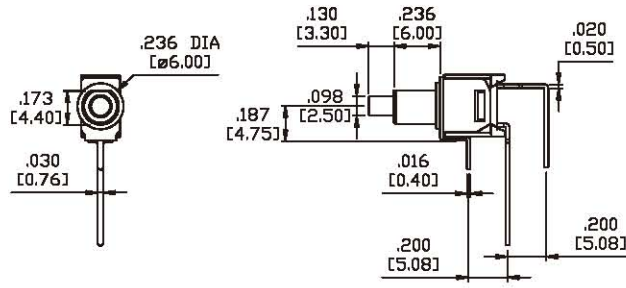

SNAP-IN TERMINATION OPTIONS

M61

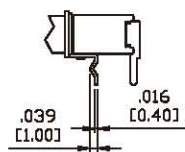

M71

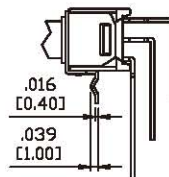

VS21

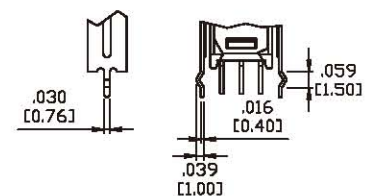

* PC Mounting for M61,M71,VS21 refer to M6,M7,VS2 respectively.

Toggle
Rocker
Slide
Pushbutton
AV
Rotary
Tact
Touch Key
Miscellaneous

PLUNGER CAPS

C1

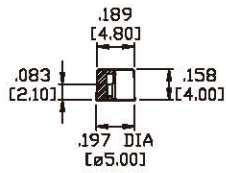

* MATERIAL: ABS.

C2

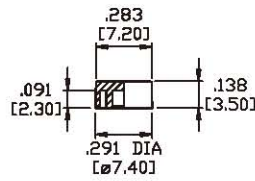

* MATERIAL: ABS.

C3

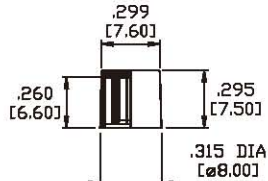

* MATERIAL: ABS.

C4

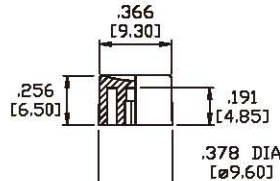

* MATERIAL: ABS.

CAP AND FRAME COLORS	
1	White
2	Black
3	Red
4	Orange
5	Yellow
6	Green
7	Blue
8	Brown
9	Gray

* C3 & C4 cap is only for plunger with B8 and B0 bushing.

CONTACT MATERIAL OPTIONS

Coding	Contact Material	Terminal Plating	Rating	Agency Approvals
Q	Silver ¹	Silver plated ¹	1Amps @ 125VAC or 28VDC	
P		Tin plated ^{5, 7}		
R	Gold ²	Gold plated ⁴	0.4VA max @ 20V max (AC or DC)	
K		Tin plated ^{5, 6}		
G	Silver ¹	Gold over silver ³	1Amps @ 125VAC or 28VDC	

- 1. Movable Contact / Terminals: Copper alloy, silver plated.
- 2. Movable Contact: Copper alloy with gold plated over nickel plated.
- 3. Terminals: Silver plated with outer layer in gold plating.
- 4. Terminals: Copper alloy, with gold plated over nickel plated.
- 5. Outer Terminals: Copper alloy with pure tin plated.
- 6. Terminal Contact: Gold plated over nickel plated.
- 7. Terminal Contact: Palladium nickel alloy (or Silver) plated.

* P, K is not available with M1 terminal.