

SPECIFICATIONS:

RATING: 30VDC 500mA.
 OPERATING FORCE: 50gf max.
 LIFE: 100,000 cycles min.
 CONTACT RESISTANCE: 100m-ohms max (initial).
 INSULATION RESISTANCE: 100M-ohms min (500VDC).
 DIELECTRIC STRENGTH: 250VAC 1 min.
 OPERATING TEMPERATURE: -15°C to +70°C.
 AMBIENT HUMIDITY: 35%~85%RH.

MATERIALS:

BODY: PBT.
 COVER: POM.
 LEVER: POM or SUS.
 BUTTON: POM.
 CONTACT: BeCu+Ag.
 TERMINAL: Silver+Ag.

Specifications and Dimensions subject to change

SSM-00

SCHEMATIC

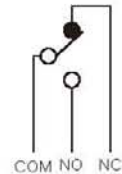
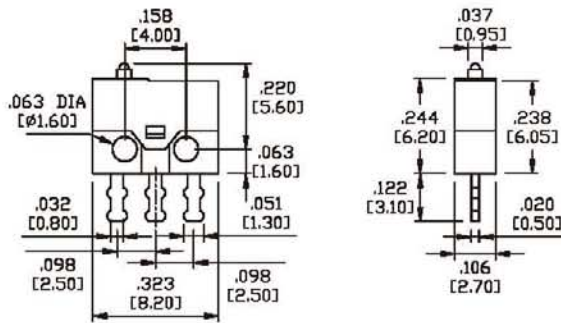

SSM-01

SCHEMATIC

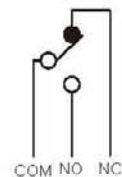
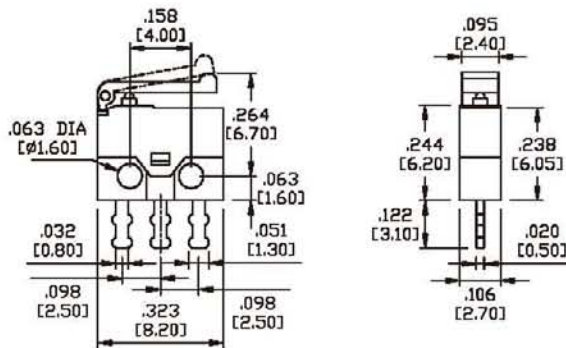

SSM-02

SCHEMATIC

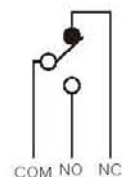
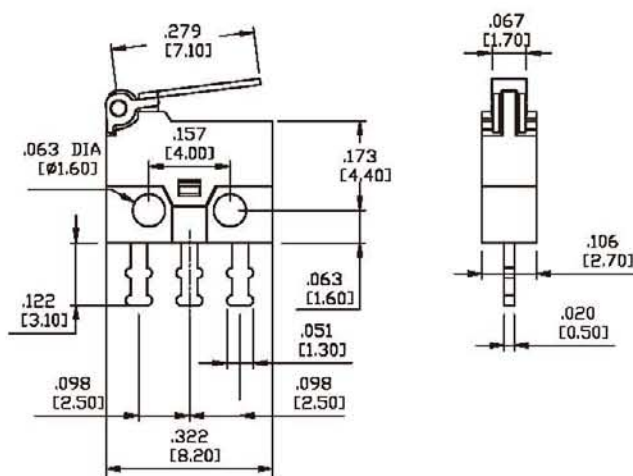

TERMINATION OPTIONS

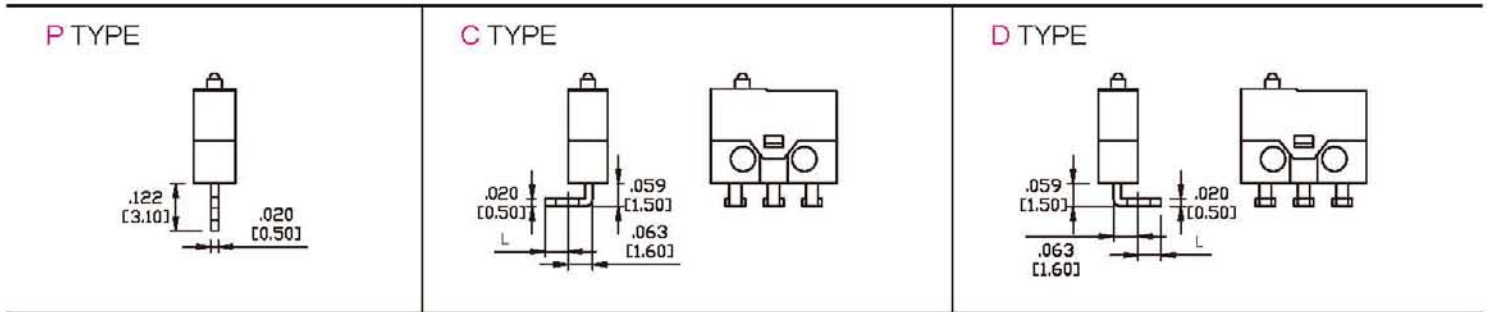

HOW TO ORDER

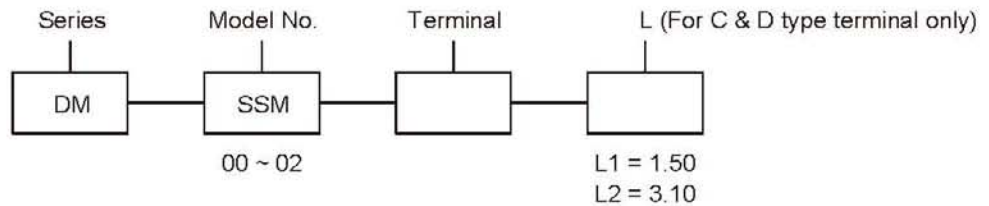

SPECIFICATIONS:

RATING: AC125V 1A, (OPTIONAL AC125V @ 3A, 0.1A @ 250VAC).
 INSULATION RESISTANCE: >100M-ohms DC500V.
 DIELECTRIC STRENGTH: AC500V 1 min.
 CONTACT RESISTANCE: <50m-ohms.
 SOLDERING TEMPERATURE: 225°C max. 5 sec.
 MECHANICAL LIFE: 1,000,000 cycles.
 ELECTRICAL LIFE: 30,000 cycles.
 OPERATING TEMPERATURE: -25°C to +65°C.
 AMBIENT HUMIDITY: <85% RH.

Specifications and Dimensions subject to change

DM-00

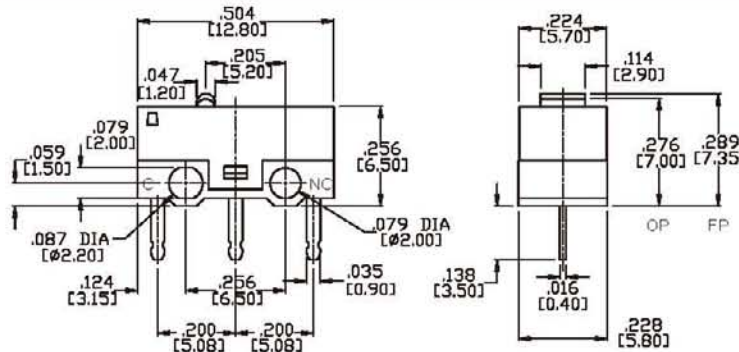

SCHEMATIC

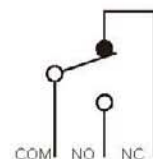

LEVER OPTIONS

DM-01

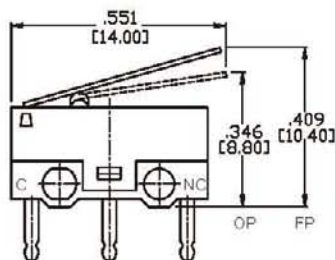

DM-02

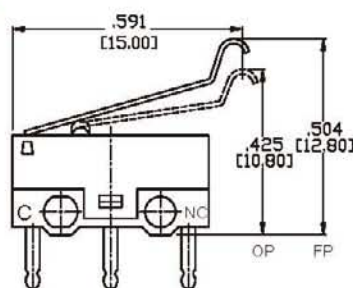

DM-03

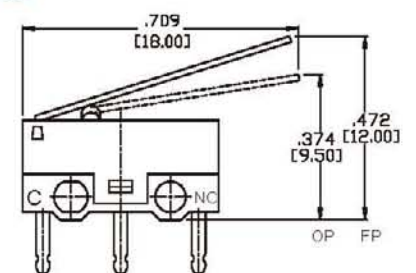

TERMINATION OPTIONS

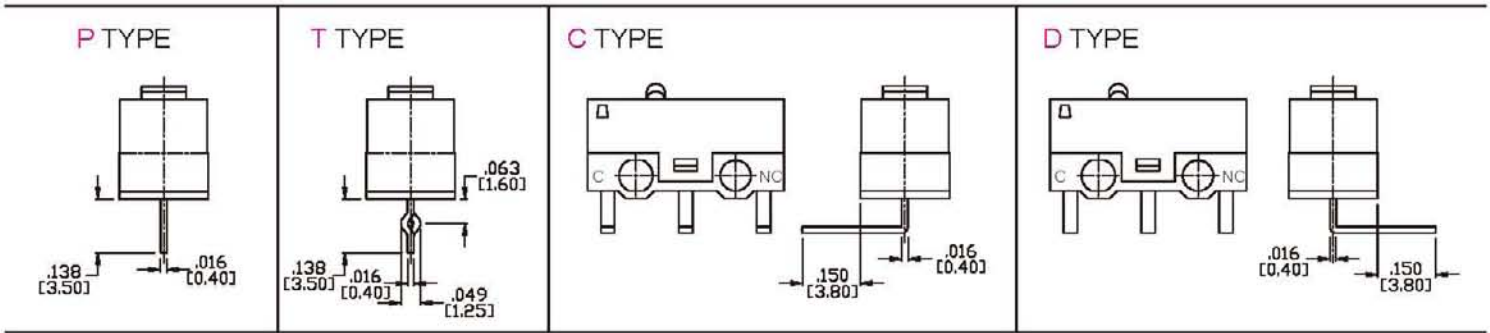

HOW TO ORDER

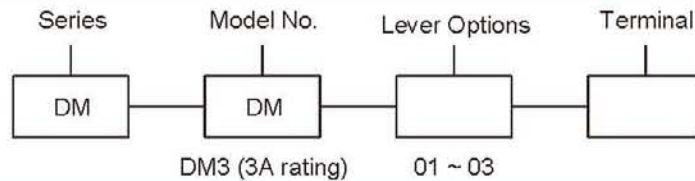

SPECIFICATIONS:

RATING: AC 125V 3A (OPTIONAL AC125V @ 5A).
 INSULATION RESISTANCE: >100M-ohms DC500V.
 DIELECTRIC STRENGTH: AC1000V 1 min.
 CONTACT RESISTANCE: <50m-ohms.
 SOLDERING TEMPERATURE: 225°C max. 5 sec.
 MECHANICAL LIFE: 1,000,000 cycles.
 ELECTRICAL LIFE: 200,000 cycles.
 OPERATING TEMPERATURE: -25°C to +80°C.
 AMBIENT HUMIDITY: <85% RH.

Specifications and Dimensions subject to change

SM-00

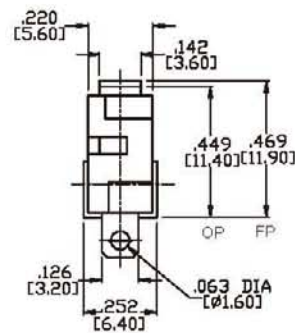
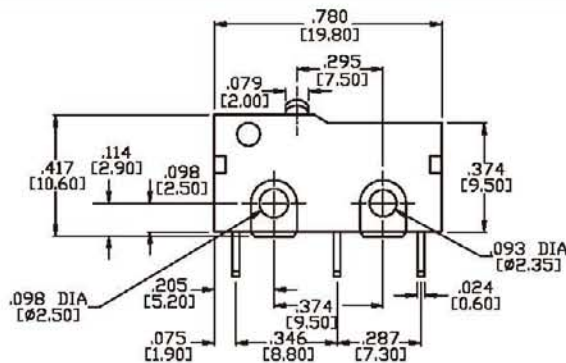

SCHEMATIC

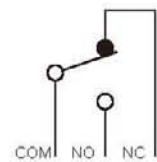

LEVER OPTIONS

SM-04

SM-05

SM-06

Model No.	DIM. "A"
SM-01	.571 [14.50]
SM-02	.650 [16.50]
SM-03	.890 [22.60]
SM-07	1.685 [42.80]

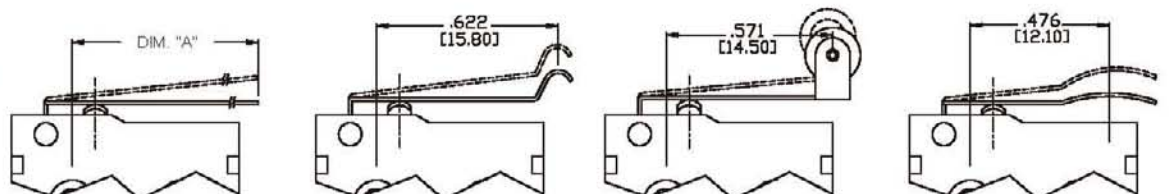

TERMINATION OPTIONS

M1

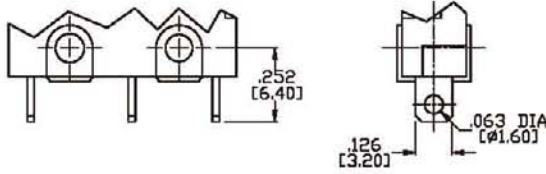

M2

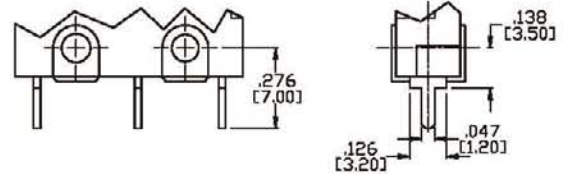

HOW TO ORDER

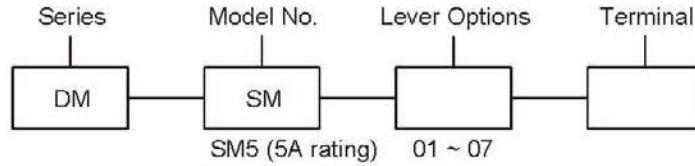

SPECIFICATIONS:

- RATING: AC125V 3A (OPTIONAL 5A @ 125VAC, 0.1A @ 250VAC).
- INSULATION RESISTANCE: >100M-ohms DC500V.
- DIELECTRIC STRENGTH: AC1000V 1 min.
- CONTACT RESISTANCE: <100m-ohms.
- SOLDERING TEMPERATURE: 225°C max. 5 sec.
- MECHANICAL LIFE: 5,000,000 cycles.
- ELECTRICAL LIFE: 200,000 cycles.
- OPERATING TEMPERATURE: -25°C to +80°C.
- AMBIENT HUMIDITY: <85% RH.

Specifications and Dimensions subject to change

VM-00

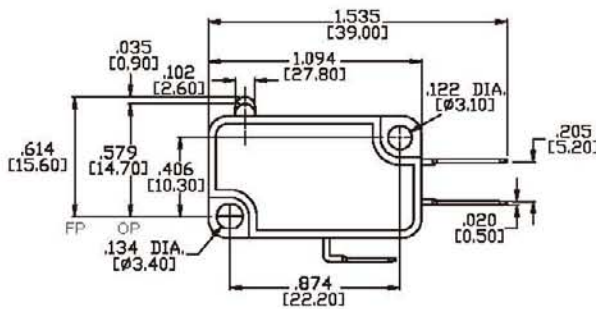

SCHEMATIC

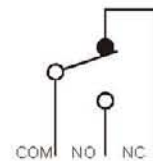
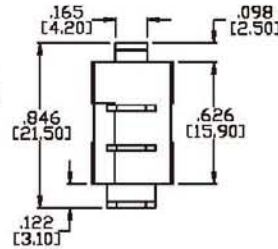

LEVER OPTIONS

VM-04

VM-05

VM-06

Model No.	DIM. "A"
VM-01	.531 [13.50]
VM-02	1.071 [27.20]
VM-03	2.012 [51.10]

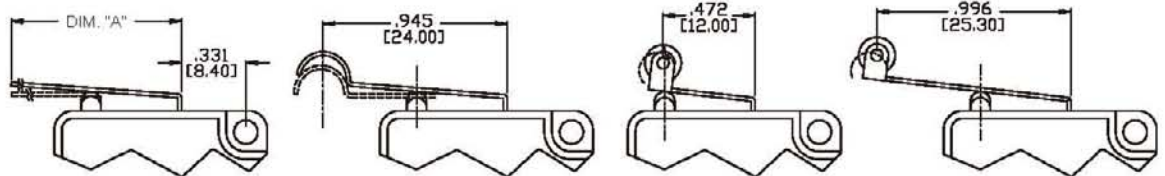

TERMINATION OPTIONS

A TYPE

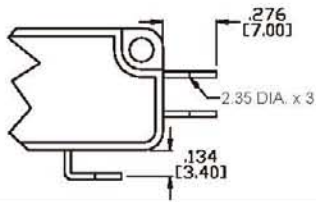

B TYPE

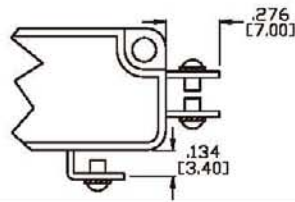

C TYPE (QUICK CONNECT 250 series)

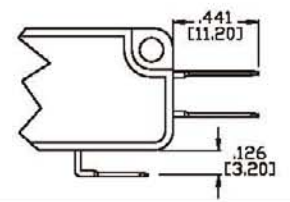

HOW TO ORDER

